

Picking a Project Idea: Think **BIG** to Start

Thinking Big: Segway Example



Problems

- **Scale:** Too Big...Accommodates adults!
- **Power:** Large Power Source and Actuators
- **Complex Control**
 - Gyro Stabilized
 - High Center of Gravity

Simplified 373 Project

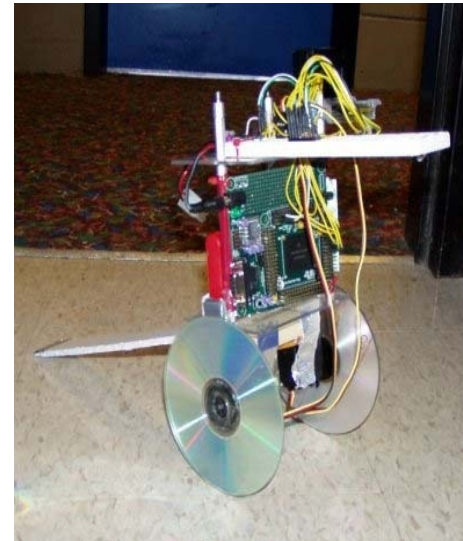

Solution

- **Scale:** Scale Down 1' High
- **Power:** Low Power, Hobby Servo Actuators
- **Simple Control**
 - "Tail" controls variable resistor
 - Low Center of Gravity

Types Of Projects: Music

Air Guitar

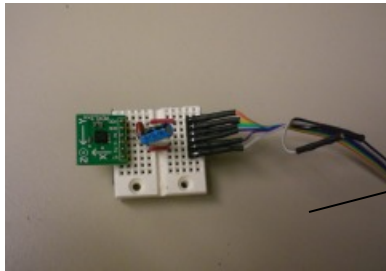

Guitar Pick air action is modeled with 3 axis accelerometer.



Music created by sending MIDI codes to MIDI synthesizer.

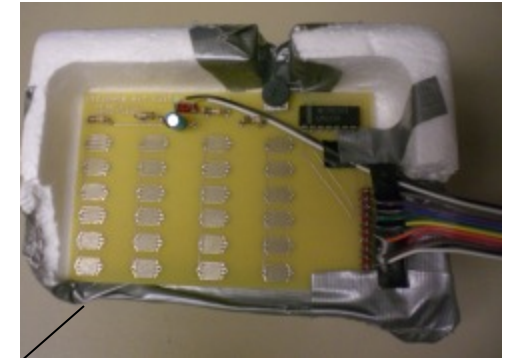

Touch key matrix to emulate fret board of guitar. Fabricate with PC board.



Types Of Projects: Concept Auto Balancing Teeter Totter



Angle position
controlled by
propeller speed

Angle is maintained
with feedback
control.

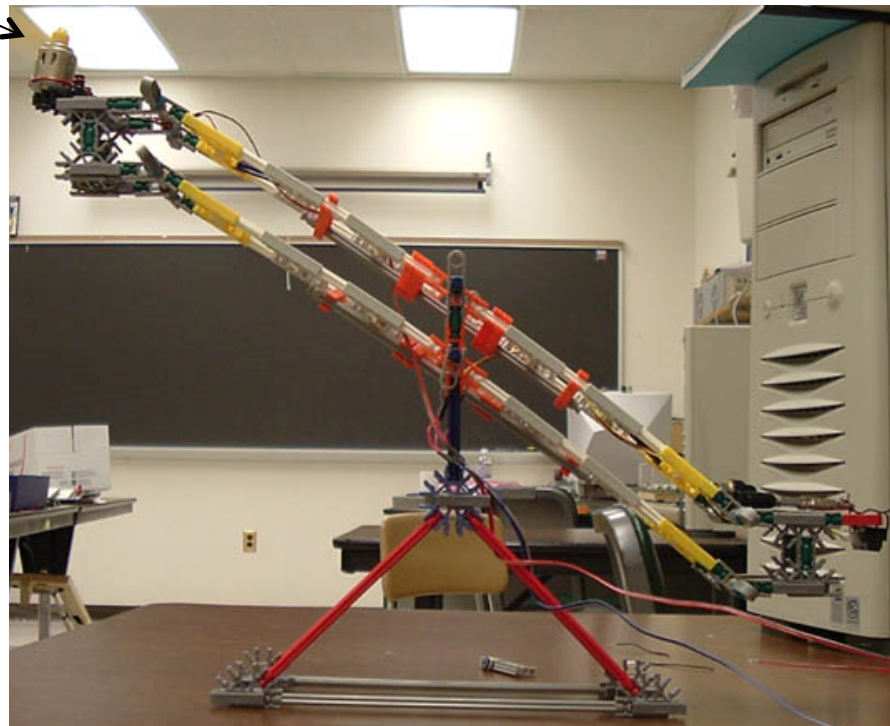

Construction by Knex

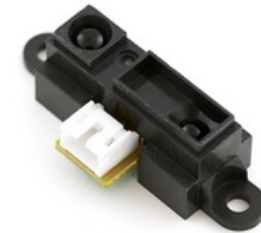

Infrared distance
sensor to measure
height

Types Of Projects: Robotic Knight Ryder

- Featured gyros and accelerometers for inertial guidance (really).
- Spoiler was added to maintain traction and stability at high speeds! (probably cosmetic).

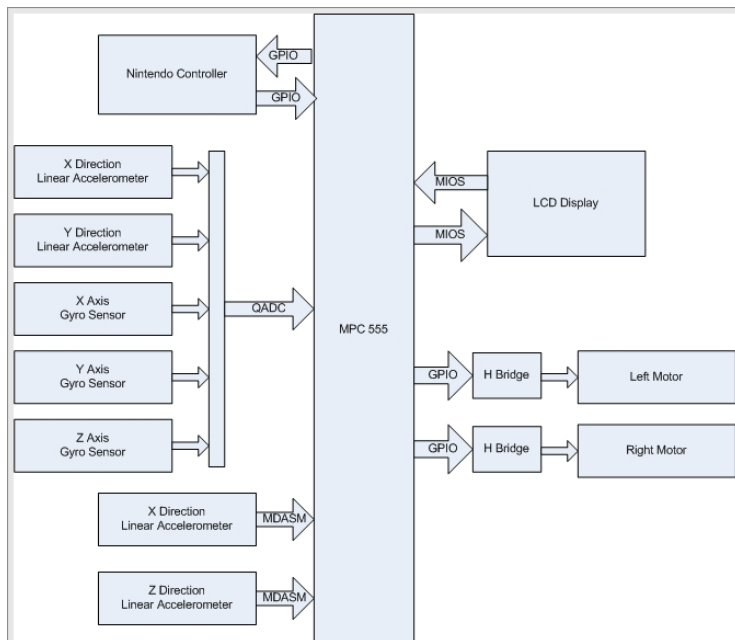

Graphics display indicating heading and position



Types Of Projects: Gaming Space Invaders

Intense gaming
in the 373 lab!



Classic game
controllers: N64
and N8

Graphics
display
indicating
the
termination
of Earth!

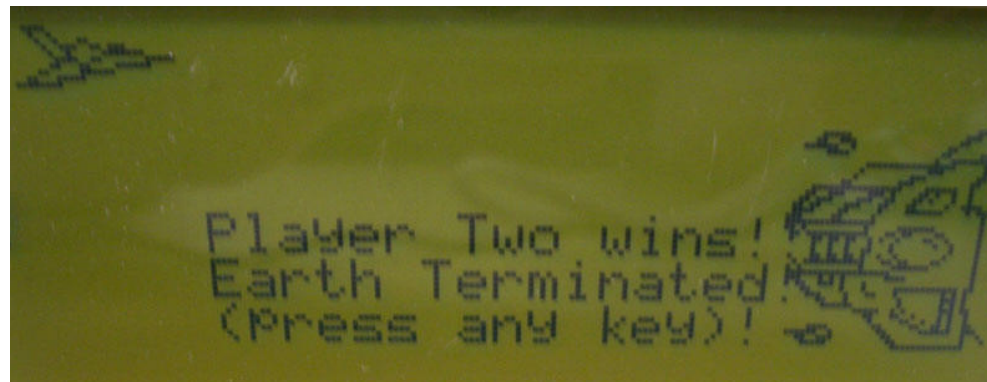

Types Of Projects: Measurement Radar

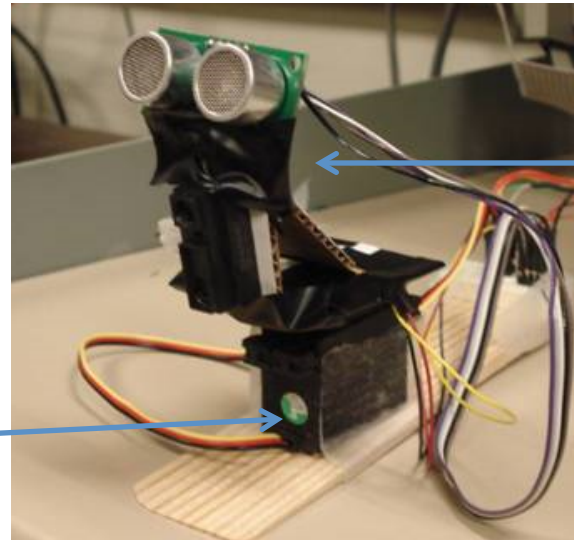

Servo provided angular sweep.

IR and Ultrasonic Sensor for Ranging



Advertisement



Reflections plotted as function of angle and distance

Types Of Projects: Research

Wireless Power Monitoring

Objectives

- Contained in 1 cubic inch
- Wireless transmitting info to central monitor and control
- Low power
- Low cost (in quantity)

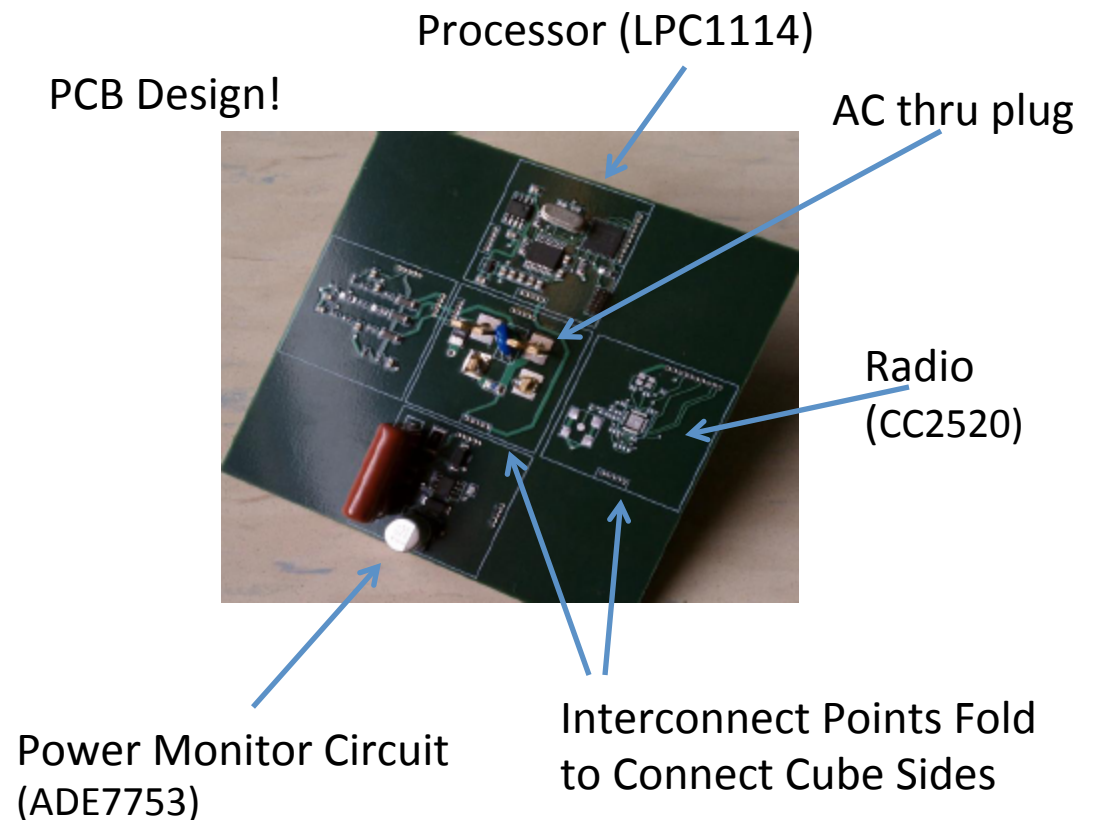

Research Projects

- Professor Dutta will provide a list of potential research oriented projects.

Idea Starting Points

- Review Past 373 Projects
 - <http://www.eecs.umich.edu/courses/eecs373/Labs/Web/projects.html>
 - Search YouTube 373 projects
 - Provides Sense of Scale
 - Use Typical Devices
 - Range of Applications
 - Many of these projects were not portable because of kit restrictions!
- Review Cornell Projects Web Site
 - <http://instruct1.cit.cornell.edu/courses/ee476/FinalProjects/>
 - Feedback control oriented, but lots of applications
 - More devices to consider
- Research Oriented Projects
 - Prof Dutta will provide a list?
- YOU!
 - Have a big cup of coffee and dream
 - Pick something you want to do!!
 - Think about all the embedded applications around you
 - Consider variants
 - Consider improvements
 - Research the application (know something about it!)
 - Discuss your ideas with potential partners and friends
 - Discuss your ideas with 373 staff

Forming Groups

- Group sizes: 2 – 4
- Larger Groups
 - Advantages: Do more complex projects
 - Disadvantages: Challenging group management, unknown relationships
- Smaller Groups
 - Advantages: Group dynamic is simpler, task management, known relationship, etc
 - Disadvantages: Possibly limits project complexity
- Start with existing Lab Partner or form new groups

Project Advising

- Matt Smith
 - Next week
 - watch for announcement (hopefully next week)
 - During lab
- Prof Dutta
 - Ask during office hours
- Lab Staff
 - Ask during lab hours

Proposal

- Due: To be determined (see project schedule)
- Contents
 - List Group Members
 - Goal Statement: In general terms describe your application?
 - Functional Specification
 - List and Describe High Level Functions
 - High Level Functional Diagram
 - Preliminary Component List
- Proposal Reviews
 - Will be determined
 - Look for announcement for review appointments.

Proposal Example

Goal Statement

For our project we intend to build a sound level meter. Sound level meters are used in applications ranging from environmental noise management to balancing sound systems in concert halls.

Our meter will approximate the Extech Model 407764. We will attempt emulate some the meter's basic functionality, but with out the same precision or reference accuracy.

The meter will have the following basic functions:

- 1.Sound level measurement with A and C frequency weighting
- 2.Time weighting from 1 – 100 seconds
- 3.Linear and logarithmic display of sounds level
- 4.Manual (4 ranges) and auto ranging
- 5.Data logging for 1 hour
- 6.PC interface to hyper terminal for ASCII file time series file storage of data log.



Functional Description

- Sound Measurement
 - Microphone: Commercial sound meters use expensive microphones. We will use a simple audio mic that will not have the same sensitivity, but can be frequency compensated.
 - Signal Conditioning: An audio amplifier will have to be provided to provide gain to the ADC.
 - Signal Conditioning: An anti-aliasing filter will have to be provided to for audio frequencies. We will use an active filter.
- Data Acquisition
 - The ACE will be setup to acquire data with 10 bit resolution and sample frequency of 40khz.
- Frequency Measurement
 - An FFT over the audio range will be performed using SmartFusion FFT core.
- Display
 - Display sound level digitally, simply analog meter graphic, measurement modes, etc.
- Key Pad
 - User input: measurement modes, display options, etc

Functional Diagram

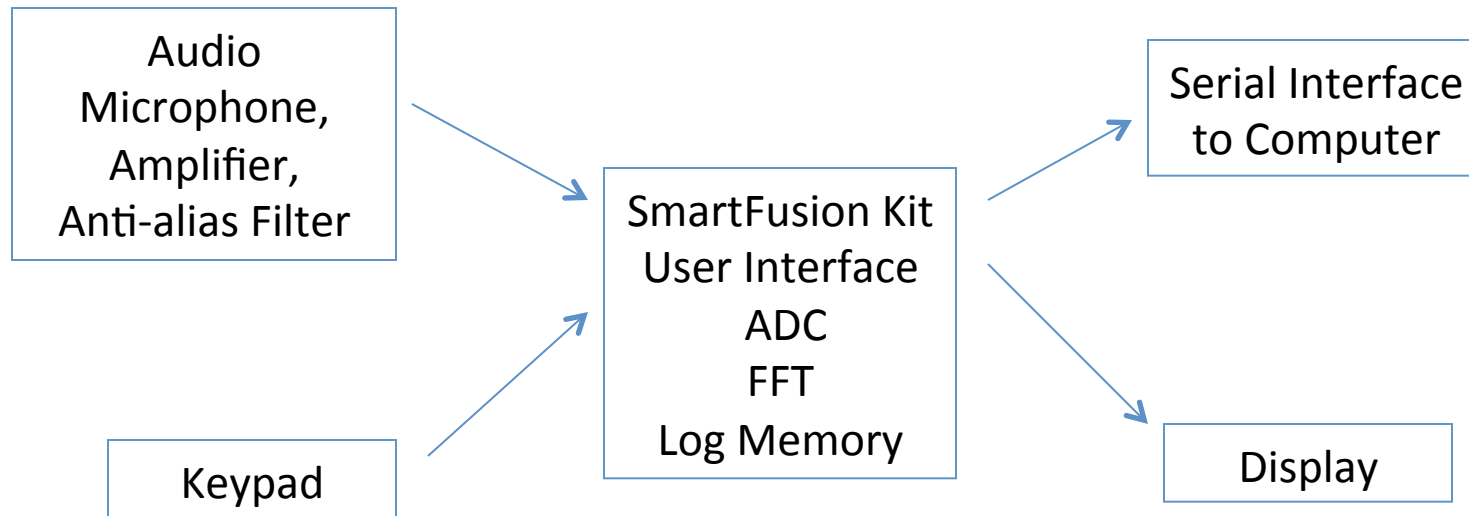

Component List

- Describe component
 - Simple audio microphone used for basic audio applications. Provides sufficient frequency response and sensitivity. Uni-directional for measurement application.
- Manufacture and Part Number
 - Audio-Technica ATR1100
 - Technical Reference: http://www.audio-technica.com/cms/wired_mics/f2f73c3430649b88/index.html
- Vendor (distributor) and vendor part number
 - zZounds, part number is manufacturer's number
- Vendor link
 - <http://www.zzounds.com/item--AUTATR1100>
- List Price: \$9.95
- Image: Consider a providing a screen shot. This can be useful during reviews.

Component List

- Microphone

- Description: Simple audio microphone used for basic audio applications. Provides sufficient frequency response and sensitivity. Uni-directional for measurement application.
- Manufacture: Audio-Technica ATR1100
- http://www.audio-technica.com/cms/wired_mics/f2f73c3430649b88/index.html
- Supplier: zZounds, part number is manufacturer's number
- Supplier Link: <http://www.zzounds.com/item--AUTATR1100>
- List Price: \$9.95
- Image:



- Miscellaneous Analog Components (lab supplies)

- Audio Amplifier: 2, LM741 or equivalent
- Bypass capacitors: 100uf
- Audio Coupling Capacitors: 1 uf
- Resistors: Assorted
- Potentiometer: 10k

Component List

- Display: Character Display with Key Pad interface and serial IO.
 - Description: 20x 4 Character display with character define capability for simple graphics. UART or I2C interface. Keypad input with controller.
 - Manufacture: Max Orbital LK204-25
 - Technical Reference: http://www.matrixorbital.ca/manuals/LK_series/LK204-25/LK204-25.pdf
 - Supplier: Digikey part number 635-1024-ND link
 - Supplier Link
<http://search.digikey.com/scripts/DkSearch/dksus.dll?Detail&name=635-1024-ND>
 - List price: \$69.95
 - Image



Component List

- Keypad
 - Description: 4x4 keypad membrane style (connects to display LK204-25)
 - Manufacturer: NKK switches FMBN16BE
 - Technical Reference: <http://www.nkkswitches.com/media/pdf/membrane.pdf>
 - Supplier: Digikey
 - Supplier Link
<http://search.digikey.com/scripts/DkSearch/dksus.dll?Detail&name=360-2297-ND>
 - List Price: \$25
 - Image

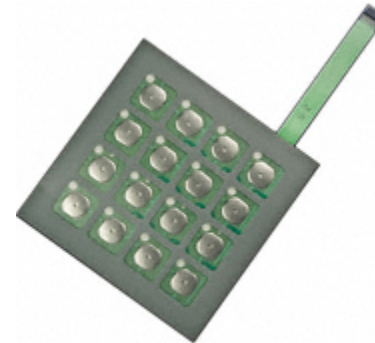

Component List

- Enclosure

- Description: 7.3"x5.8"x3.0" ABS
- Manufacturer: JAMECO VALUEPRO 203-112F-1-R
- Technical Reference: <http://www.jameco.com/Jameco/Products/ProdDS/141859.pdf>
- Supplier: Jameco
- Supplier Link http://www.jameco.com/webapp/wcs/stores/servlet/Product_10001_10001_141859_-1?CID=PDF
- List Price: \$11.95
- Image



- Batteries

- Standard 9 volt battery (lab supplies or o

- 9 volt battery connector with connector leads

- Vendor: Jameco A104-R or equivalent
- http://www.jameco.com/webapp/wcs/stores/servlet/Product_10001_10001_11280_-1?CID=PDF
- List Price \$0.39



Component Issues

- Check to see if there is stock!
 - Most vendors list available stock
- Check if there are inherent shipping delays
 - Overseas
 - Indirect Shipping
 - Small private supplier (ebay)
- What is the budget?
 - Relative price and long term use will determine affordability
- Consider lower cost alternatives
 - Reduced performance (range, precision, smaller display, smaller actuator, etc)
 - No controller (I2C interface vs analog)

Suppliers

- Digikey: Major electronic supply house
- Jameco: Many components but significantly cheaper than many vendors.
- Sparkfun: Great electronics hobby source
- Acroname: Robot hobby oriented. Lots of components
- Pololu: Electronic hobby oriented. Lots of sensors.
- Servo City: Lots of servos and actuators
- Images Scientific: Unusual sensors <http://www.imagesco.com/>
- There are lots of alternate suppliers. Search the web!!

Alternate Kits: Cypress SoC

- CY8CKIT-014 PSoC[®] 5 FirstTouch[™] Starter Kit
- Programmable system-on-chip design methodology and architecture.
- 32-bit ARM Cortex-M3 CPU core
- On board sensors
 - Accelerometer
 - Thermistor
 - Proximity Sensing
 - CapSense[®] touch-sensing interface,
 - 12-pin wireless module header
 - 28 general purpose I/O pins (GPIOs)
- Several available
- <http://www.cypress.com/?rID=43674>



Alternate Kits: LPCXpresso



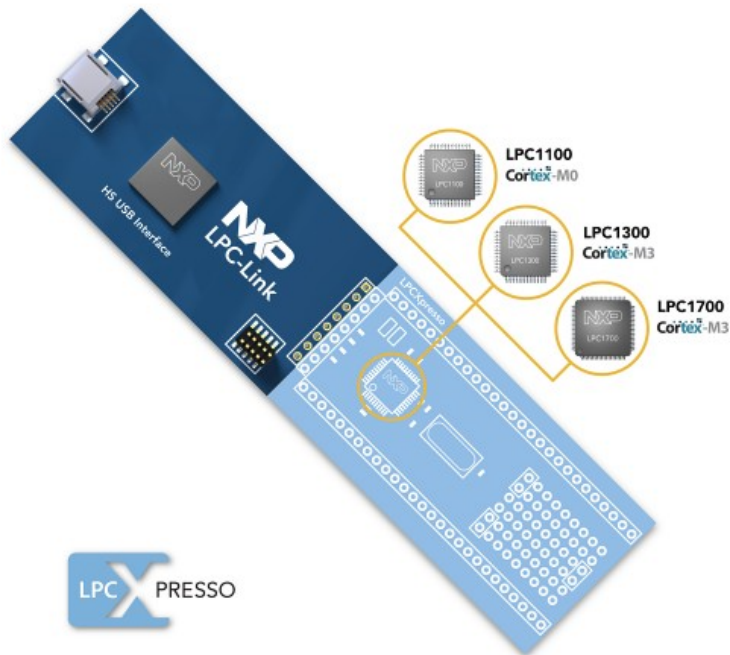



























- NXP's low-cost ARM based development platform
- Small foot print
- Break away development kit



Separated LPC-Link

Alternate Kits: LPCXpresso

Many kits varying in ARM processor and peripherals.
See <http://ics.nxp.com/lpcxpresso/>

DAC	
 LPC1768	ARM Cortex-M3 microcontroller with 512KB flash, 64KB SRAM, 10/100 ethernet, USB 2.0 Host/Device/OTG, 2 CAN, I ² S, 12-bit ADC, 10-bit DAC updated
 LPC1769 	ARM Cortex-M3 microcontroller with 512KB flash, 64KB SRAM, 10/100 ethernet, USB 2.0 Host/Device/OTG, 2 CAN, I ² S, 12-bit ADC, 10-bit DAC, 120MHz operation
  LPC1772 	ARM Cortex-M3 microcontroller with 64KB flash, 24KB SRAM, 2KB EEPROM, external memory controller, USB 2.0 Device, 2 CAN, 12-bit ADC, 10-bit DAC, I ² S new
  LPC1774 	ARM Cortex-M3 microcontroller with 128KB flash, 40KB SRAM, 2KB EEPROM, external memory controller, USB 2.0 Device, 2 CAN, 12-bit ADC, 10-bit DAC, I ² S new
  LPC1776 	ARM Cortex-M3 microcontroller with 256KB flash, 80KB SRAM, 4KB EEPROM, external memory controller, 10/100 ethernet, USB 2.0 Host/Device/OTG, 2 CAN, 12-bit ADC, 10-bit DAC, SD/MMC, I ² S new
  LPC1777 	ARM Cortex-M3 microcontroller with 512KB flash, 96KB SRAM, 4KB EEPROM, external memory controller, USB 2.0 Host/Device/OTG, 2 CAN, 12-bit ADC, 10-bit DAC, SD/MMC, I ² S new
  LPC1778 	ARM Cortex-M3 microcontroller with 512KB flash, 96KB SRAM, 4KB EEPROM, external memory controller, 10/100 ethernet, USB 2.0 Host/Device/OTG, 2 CAN, 12-bit ADC, 10-bit DAC, SD/MMC, I ² S new
  LPC1785 	ARM Cortex-M3 microcontroller with 256KB flash, 80KB SRAM, 4KB EEPROM, external memory controller, LCD controller up to true color XGA, USB 2.0 Host/Device/OTG, 2 CAN, 12-bit ADC, 10-bit DAC, I ² S new
  LPC1786 	ARM Cortex-M3 microcontroller with 256KB flash, 80KB SRAM, 4KB EEPROM, external memory controller, LCD controller up to true color XGA, 10/100 ethernet, USB 2.0 Host/Device/OTG, 2 CAN, 12-bit ADC, 10-bit DAC, SD/MMC, I ² S new
  LPC1787 	ARM Cortex-M3 microcontroller with 512KB flash, 96KB SRAM, 4KB EEPROM, external memory controller, LCD controller up to true color XGA, USB 2.0 Host/Device/OTG, 2 CAN, 12-bit ADC, 10-bit DAC, SD/MMC, I ² S new
  LPC1788 	ARM Cortex-M3 microcontroller with 512KB flash, 96KB SRAM, 4KB EEPROM, external memory controller, LCD controller up to true color XGA, 10/100 ethernet, USB 2.0 Host/Device/OTG, 2 CAN, 12-bit ADC, 10-bit DAC, SD/MMC, I ² S new

Alternate Kits: Others

- Should be ARM based
- Must be approved by staff
- Note: Kits like the Arduino are typically not accepted. The library support for such as large selection of devices defeats the purpose of the project.

Project Schedule

tentative (but really close)

- Week 10/19
 - 10/23 Project Overview
 - Work on Lab 7
- Week 10/26
 - Project Pitches during Tu lecture?
 - Work on project ideas
 - Seriously consider group formation and project idea.
 - Have draft proposal completed by end of week.
 - Finish Lab 7
- Week 11/2
 - Work on Projects
 - Receive components to get started
 - Have special component requests submitted.
 - **At a minimum, you should have stock components and should be starting.**
 - **Project support hours begin**
- Week 11/9
 - Work on projects
 - Receive special order components
- Week 11/16
 - Work on projects
- Week 11/23
 - Work on projects
- Week 11/30
 - Work on projects
 - Submit exhibit posters by end of week to printer to be ready by following Wed
- Week 12/7
 - Project Exhibition (time and place to be determined.)
- Week 12/18
 - Project Clean up

Typical Project Devices

- The following slides are representative of typical devices.
- Many of these devices are available from Sparkfun.
- Sparkfun usually has great support and data sheets listed with these parts.
- These slides are not necessarily covered during the overview.
- Look them over as a general reference of typically components.

User Input: Keypad

- 4x4 key pad
- Supplier: ucontroller
- Interface: UART serial interface
 - <http://www.ucontroller.com>
- Or, connects directly into some serially interface displays

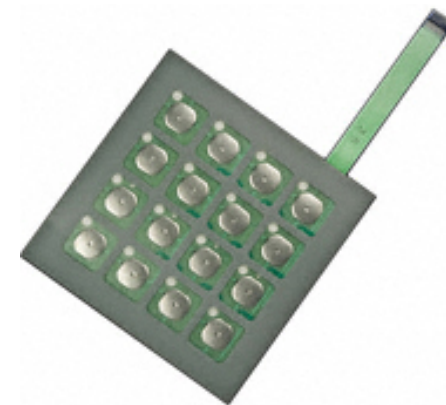

User Input: Touch Screen

- Provides XY position
- Supplier: Sparkfun LCD-08977
- Interface: 2, Digital GPIO and 2, ADC channels

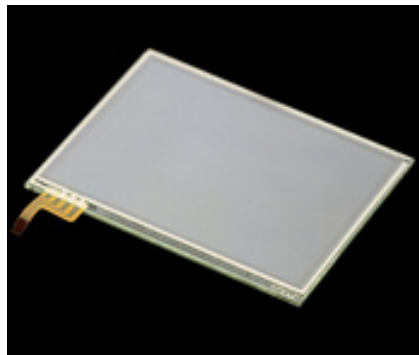

User Input: Resistive Touch

- Provides position along sensor (like iPod)
- Supplier: Sparkfun SEN-09074
- Interface: ADC (sensor is variable resistor)
- Available in rotary and linear forms



User Input: Flex Sensors

- Change resistance as function of flex
- Interface: ADC
- Vendor: Spark fun or Images Scientific Instruments

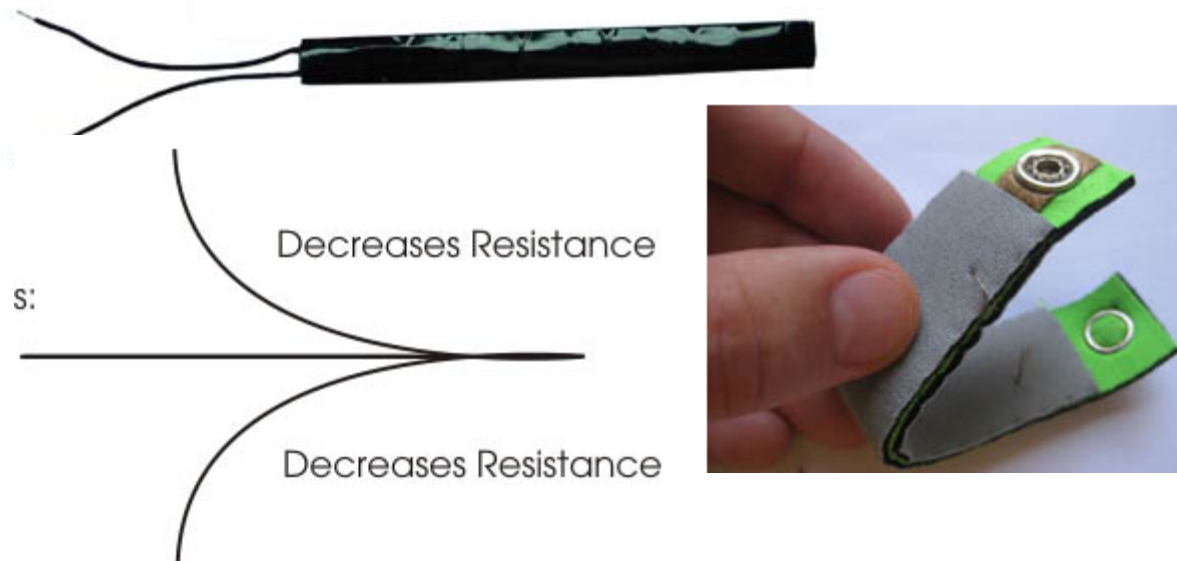

User Input: Game Controllers

- Classic Nintendo 8 and 64
- Lab Stock
- Serial Interface
 - Custom serial interface with GPIO
 - N8 simple synchronous serial
 - N64 full duplex asynch serial



User Input: Joysticks

- Used for pointing
- Sparkfun provides many varieties
- Interface: variable resistance, ADC



User Input: Other key pads

- Multi-general purpose keypad
- Sparkfun
- Require scanning matrix with many GPIO
- May require extra logic to handle matrix scanning

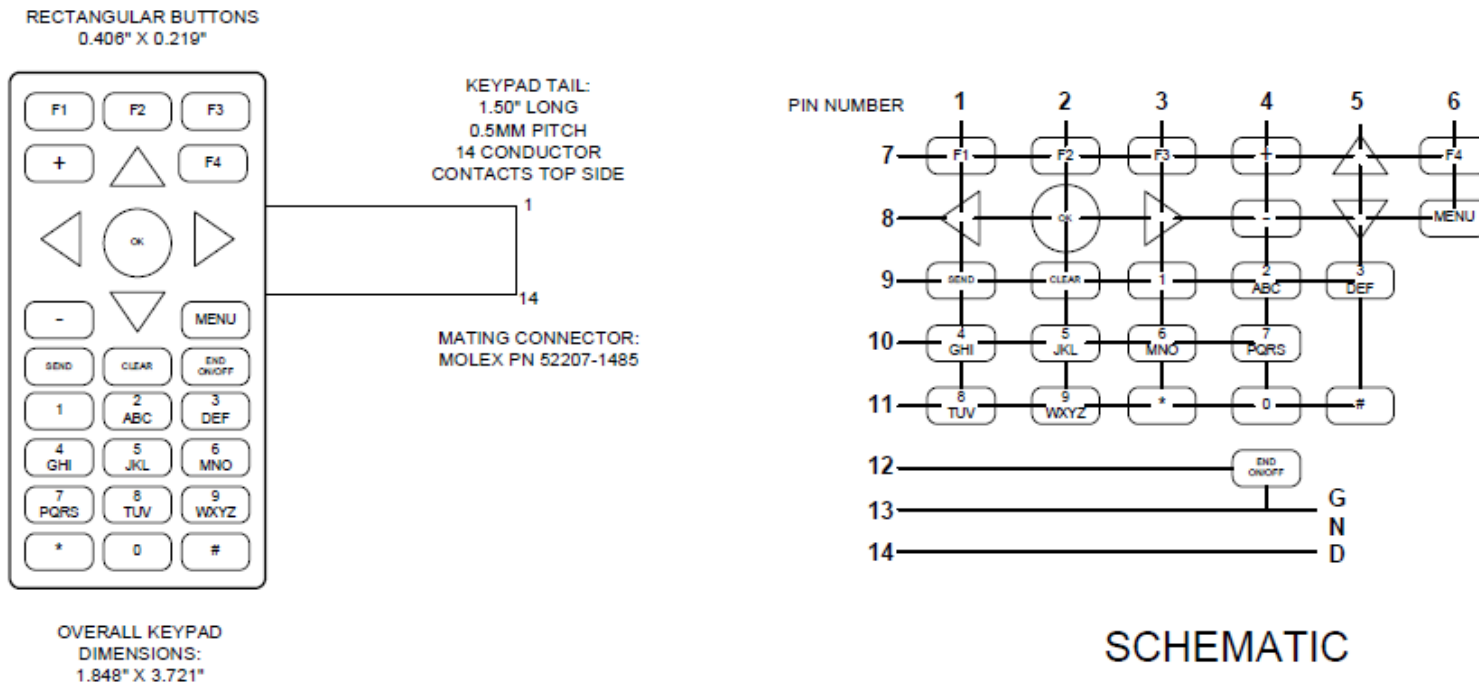

User Input: Motion Sensing

- Accelerometers
- Sparkfun ADXL335
- Analog Voltage Interface (ADC)
- 3 axis +/-3G

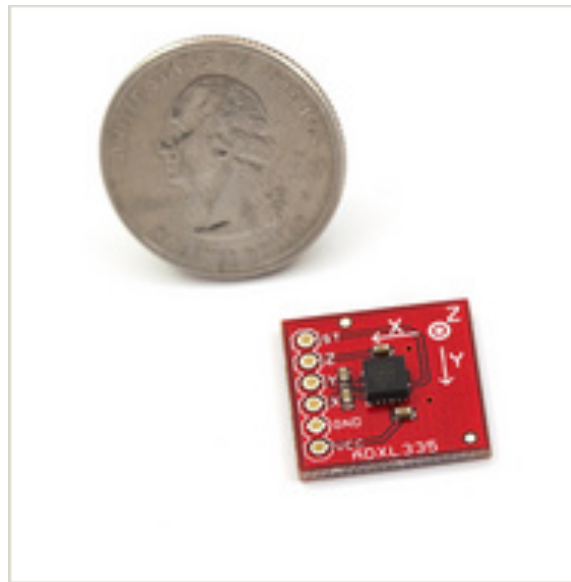

User Input: Contact

From Sparfun

- Simple Push Buttons [COM-00097](#)

- Interface: Digital IO



- Vibration [SEN-09197](#)

- Interface: Provides voltage (piezo)

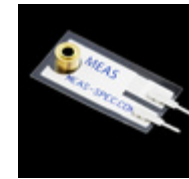

- Reflectance Sensor [ROB-0945](#)

- Interface: Digital IO



- Pressure [SEN-09375](#)

- Changes resistance with pressure



Actuators: DC Motors

- Basic DC motors

- Hard to control and generally have poor torque at low speeds.
- Ok, for high rotation speeds
- Control with H-bridge and PWM



- Gear Motors

- Use gear box for low speed control, but not very responsive.
- Control with H-bridge and PWM



Gears

Actuators: Motor Control

- H bridges are common devices to buffer and reverse the direction of a DC motor.
- Common component is the SN754410NE

754410NE provides switching and buffering

Logic diagram

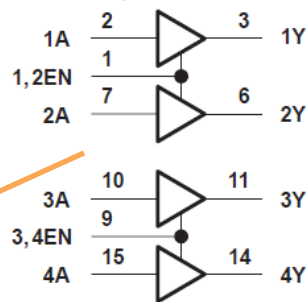

Load voltage and control voltage are independently supplied

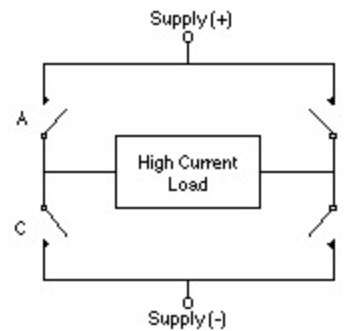

The basic H-Bridge layout.

Switch matrix can reverse voltage across load (motor)

Actuators: Servos

- Angle adjust to ± 90 degrees from center
- Available in continuous rotation models
- Interface: PWM via GPIO (easy)
- \$10 - \$40

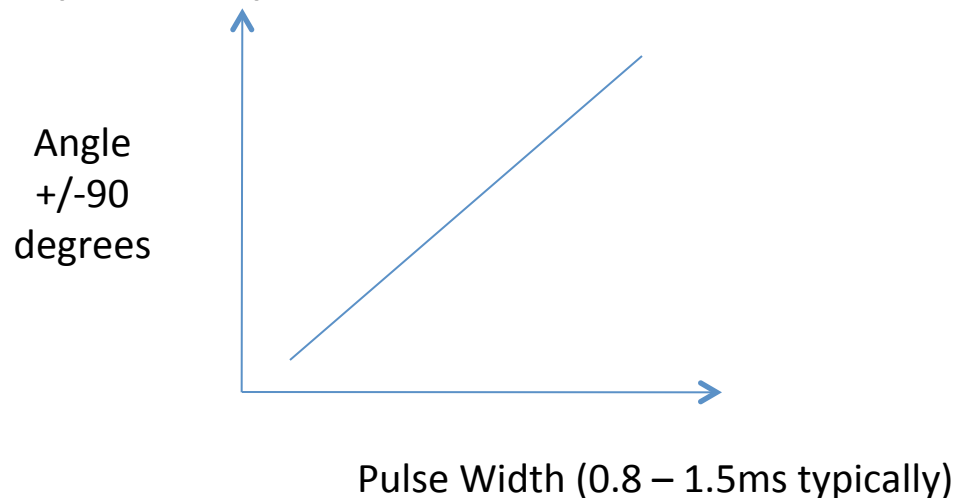

Actuators: Stepper Motors

- Good angle control with continuous rotation
- Complex interface compared to servo
- Possible to use controller with current buffer
- \$25 - \$50

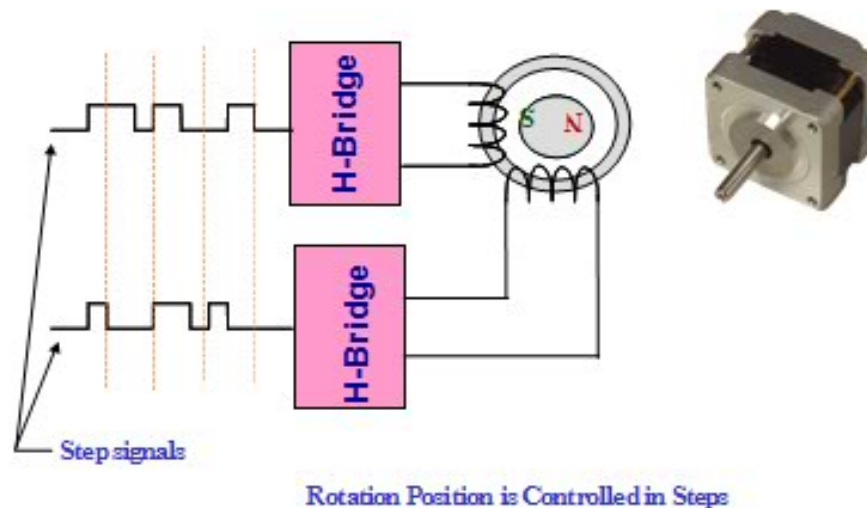

Actuators: Linear

- Motor/gear box type
- Available in different torques, response and travel
- Voltage Control (PWM)
- Linear Feedback (potentiometer)
- ~\$100
- <http://www.firgelli.com>
- <http://www.trossenrobotics.com>



Actuators: Linear

- Gear racks with motors
- Supplier: Servo City
- Or, lead screws with motors



Gears

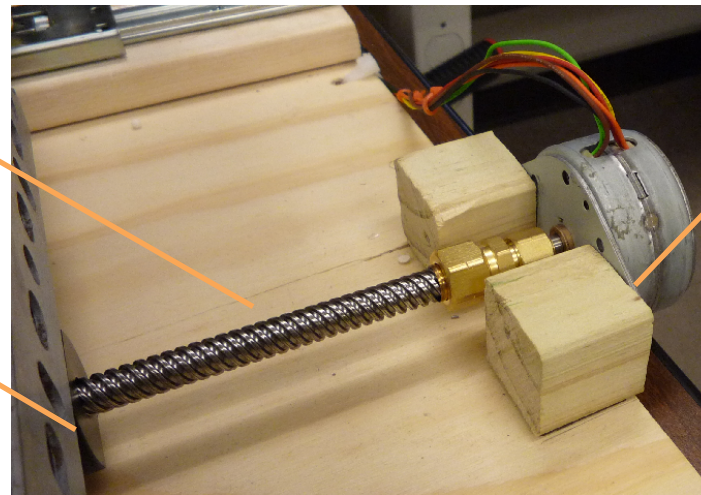
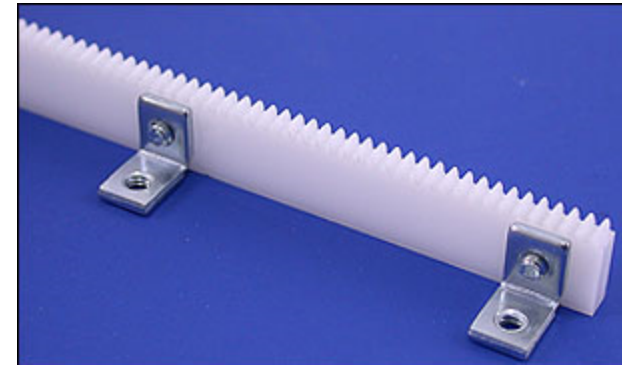

Lead Screw

Threaded Bearing

Stepper Motor or Servo

Actuators: Linear

- Solenoids
- Short Travel
- Fast
- Power hungry! 0.5amp at 12volts
- Requires buffering and isolation
- Used for pneumatic and fluid valve

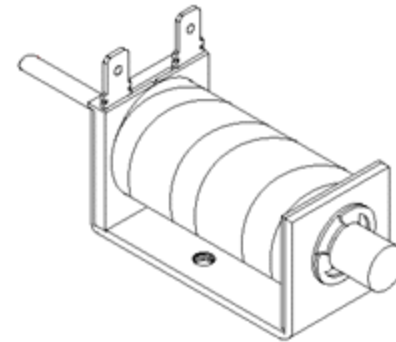

Robotic Chassis

- “Roomba” style
- Great Maneuverability
- DC motor control with H Bridge
- Lots of room for components
- Powered by standard RC batteries

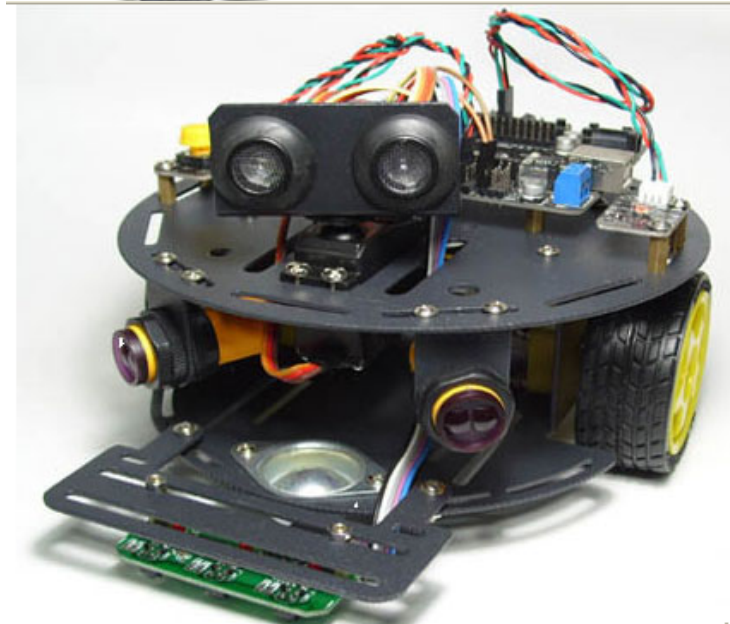

Displays: Character

- NEWHAVEN DISPLAY NHD-0216K3Z-FS(RGB)-FBW
- Serial interface: I2C, SPI or RS232
- 2 lines x 16 characters
- No bit map graphics
- \$24
- Supplier: Jameco



Displays: Character

- Matrix Orbital LK204-25
- 4x20 character display (no bit map graphics)
- 4 sets of eight custom characters
- Serial Interface: UART and I2C
- Keypad interface
- \$70
- Supplier: Digikey
- Supplier: Jameco

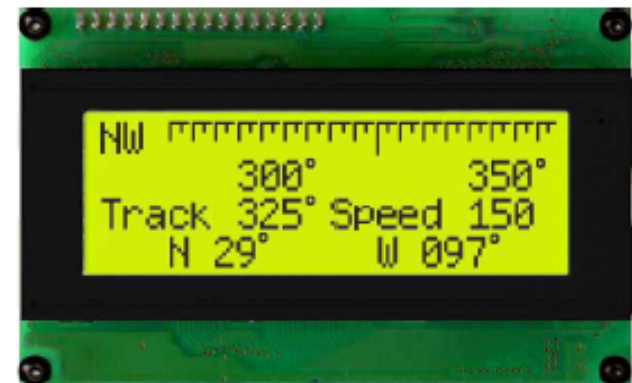

Displays: Graphic

- Matrix Orbital GLK24064-25
- 240 x 64 pixel graphics display
- text display using built-in or user-supplied fonts
- adjustable contrast
- backlighting
- keypad interface
- RS-232 (UART) or I2C communications

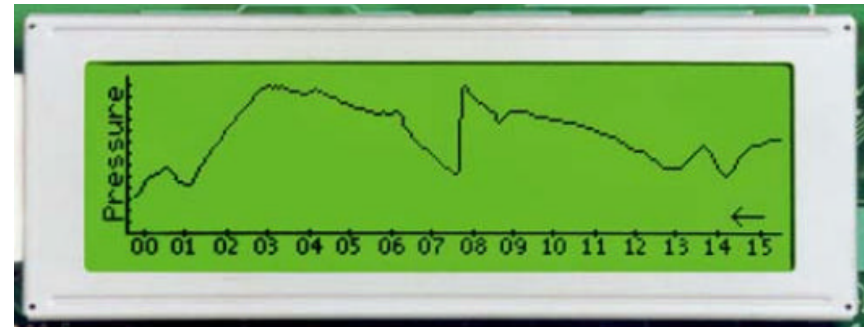

Displays: Graphics Display with Embedded Controller

- 4D Systems uLCD 32pt-GFX-DS
- 3.2 inch with touchscreen
- Embedded graphics controller
- Serial Interface
- Sparkfun \$85
- Graphics developed with high level application software.
- <http://www.4dsystems.com.au/prod.php?id=114>



Displays

- See Sparkfun for many other displays
- Consider your application and
 1. Serial Interface for easy interface
 2. Size
 3. Character vs Graphic
 4. Power consumption
 5. Cost

Sensors: Environmental

- Temperature: Thermistor
 - Resistance varies with temperature
 - Sparkfun SEN-00250, \$2
- Temperature: LM34DS analog
 - +10 mv/degree F
 - Jameco, \$2.25
- Temperature: TI TMP102
 - SPI type interface
 - Sparkfun, \$6
 - 12-bit, 0.0625°C resolution
 - Accuracy: 0.5°C (-25°C to +85°C)



Sensors: Environmental

- Humidity
- Atmospheric Pressure
- Day Light
- Various Gases
 - Alcohol
 - CO2
 - LPG
 - Methane
- See Sparkfun or search web

Sensors: Motion

- 3 Axis Accelerometers
- MMA7260Q
 - Adjustable gains ± 1.5 , 2, 4, and 6g
 - Analog voltage output
 - Sparkfun \$20
- BMA180
 - $\pm 1g$, 1.5g, 2g, 3g, 4g, 8g and 16g
 - SPI and I2C models
 - Sparkfun \$30



Sensors: Motion

- Gyros: measure angular rate, degrees/sec
- Types
 - 1-3 axis
 - Sensitivity 30 – 300 degrees/sec
 - Analog and I2C interfaces

Alternate
Gyro (not
to scale)

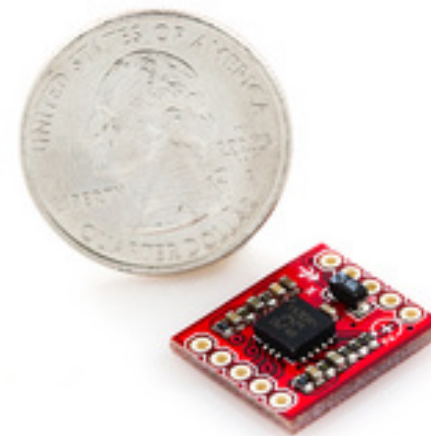

Sensors: Distance (Proximity)

- Infrared Proximity Sensor
- Target must be reflective, but may be small
- Optimized for various sensing distances 3-150
- Analog interface (cm/volt)
- Sparkfun, Acroname



15-150 cm



3-40 cm

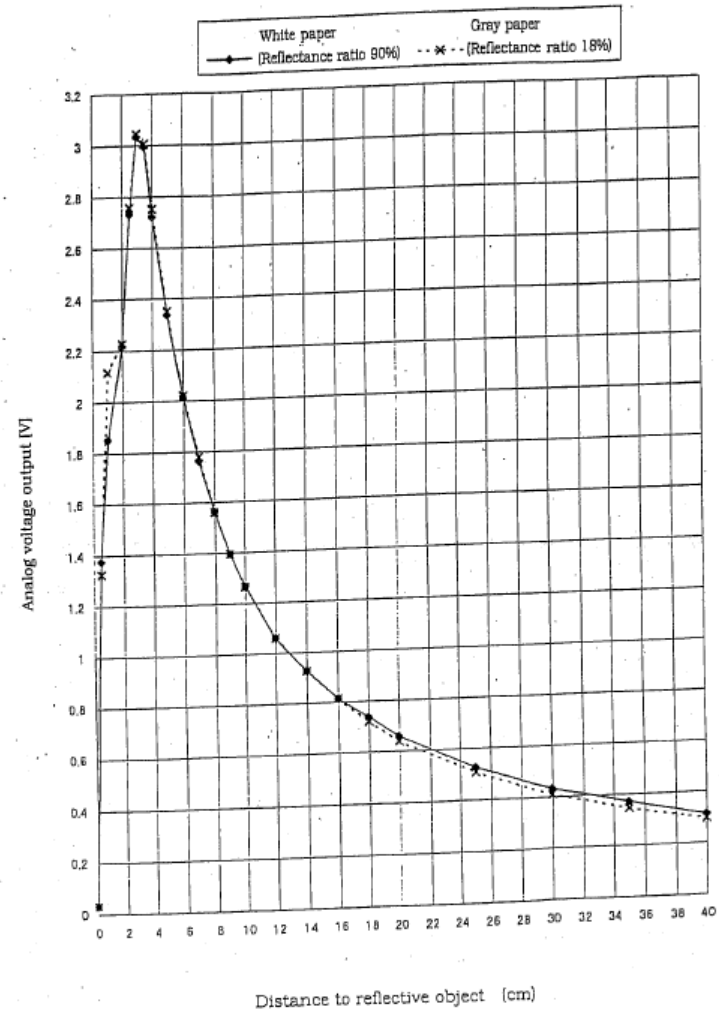

Must work in linear ~ linear region or compensate.

Sensors: Distance (Proximity)

- Ultrasonic Range Finder
- Linear and accurate 0 – 255 inches
- Interface: RS232 serial, analog or PWM
- Target size and range depends on specific models
- See selection guide
 - http://www.sparkfun.com/datasheets/Sensors/Proximity/Sensor_Selection_Guide.pdf

Different beam width trade off target and clutter sensitivity.

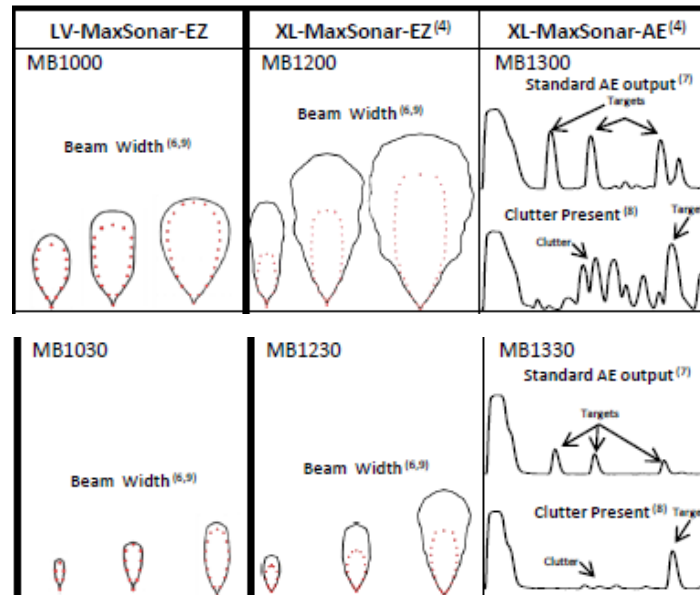

Sensors: Vibration and Sound

- Omni-Directional Electret Condenser Microphone Cartridges
 - inexpensive
 - easy to use
 - good frequency response

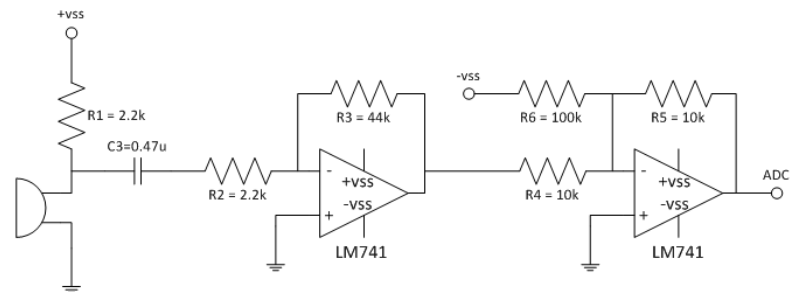
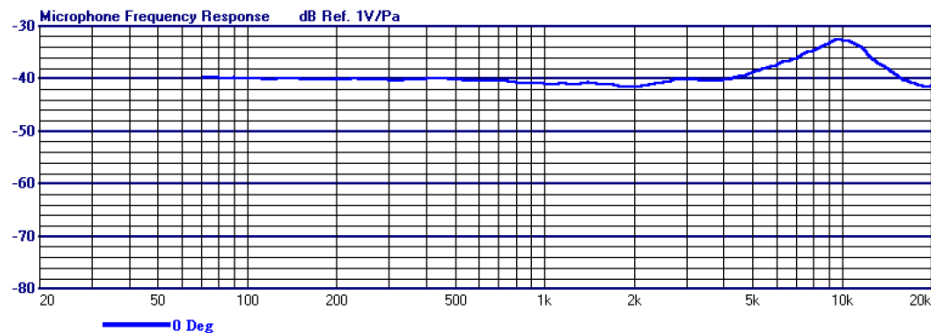

Sensors: Vibration and Sound

- Piezo Vibration Sensor
- Produce voltage in response to flex change
- Available in various sensitivities
- Low Frequency response

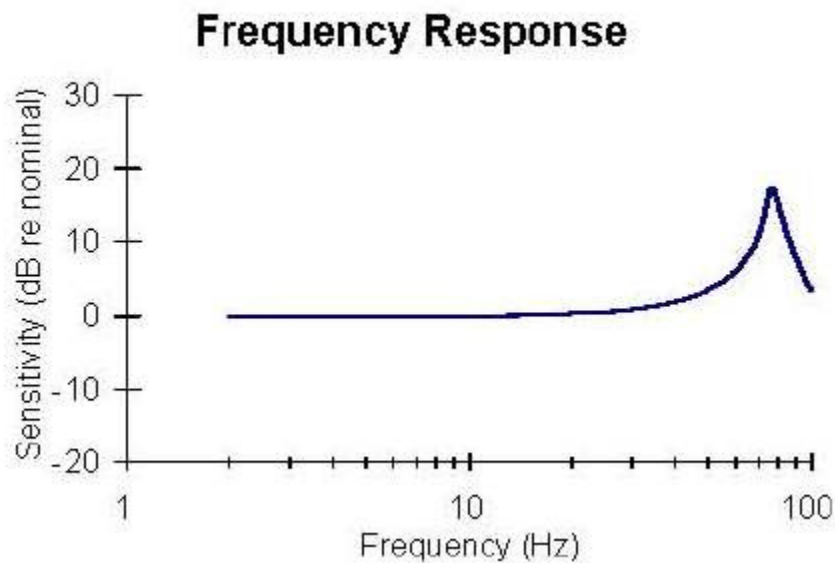

Mass, stiffness and mounting orientation varies for different apps.

Sensors: Force

- Pressure (ohms proportional pressure)
- Come in variety of geometries

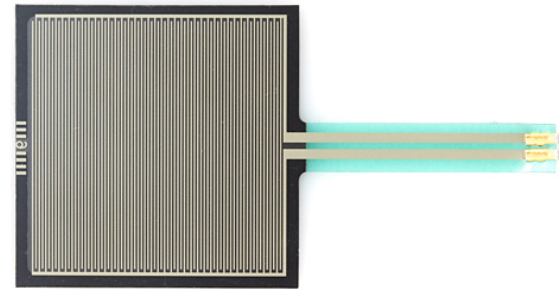

Sensors: Force

- Flex (resistance proportional to bend)
- Used in original Nintendo power glove

How It Works

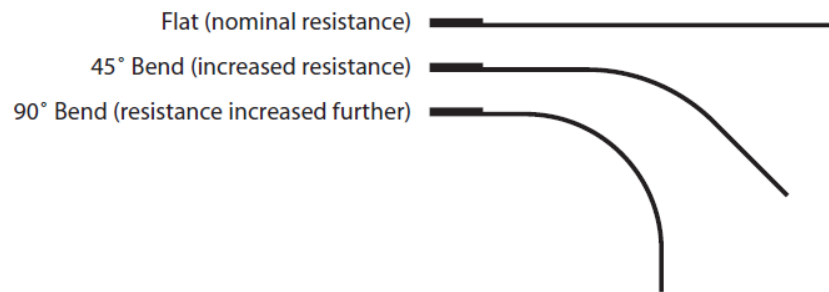

symbol

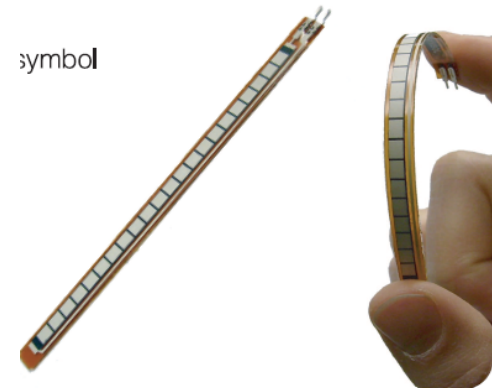

BASIC FLEX SENSOR CIRCUIT:

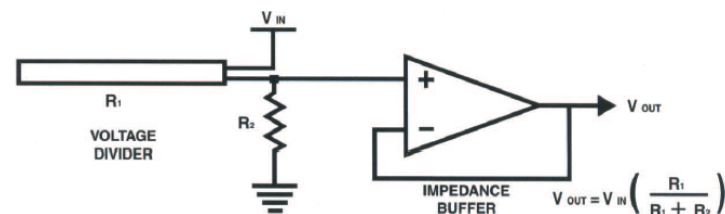

Sensors: Force

- Air pressure
- Provide 5 volt supply
- Voltage proportional to pressure
- Jameco
- Variety of sensors



Measurable pressure range (kPa)	
0~24.5	XFPN-03KPGV
0~100	XFPN-100KPGV
0~25	XFPN-025KPG
0~50	XFPN-050KPG
0~100	XFPN-100KPG
0~200	XFPN-200KPG

Sensors: Force

- IESP-12 force sensor
- resistance proportional force applied to the button
- Up to 4 Kg of force High resistance (>500K)
- Low resistance (~500 Ohms) at max loa
- <http://www.solarbotics.com/products/35170/>



Sensors: Force

- Stretch
- Resistance proportional to stretch
- Available in bulk
- <http://www.imagesco.com>

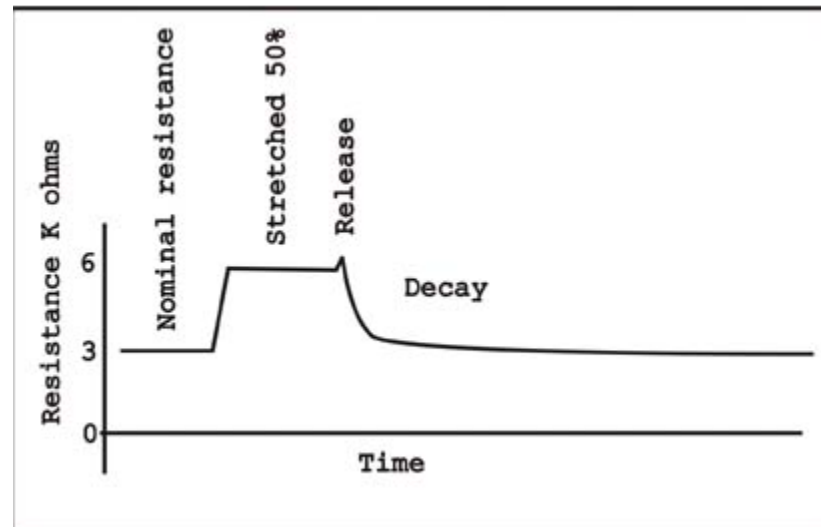

Sensors: General

- Consider your application
 - What range of sensing do I need?
 - What sensitivity?
 - What response?
 - What kind of repeatability?
- Characterize the sensor with standard lab equipment first.
- I.E. for a resistive style force sensor
 - Attach to ohm meter and apply various forces
- I.E. for an accelerometer
 - Provide power
 - Attach to oscilloscope on slow trace and observe response to different orientations in gravity

Last, but Not Least Safety Restrictions

- Safety methods must be implemented and approved for the following items:
 - **High Speed Spinning Devices:** containment
 - **Water, Pop, Food:** containment, non-toxic fabrication
 - **Projectiles:** containment, soft materials, low velocity
 - **Heat:** isolated, insulated and non-combustible levels
 - **High voltage:** consult staff for isolation methods
 - **Lasers:** shielding or containment
 - **Not Sure:** ask us

Questions?

