

THE FOCAL PLANE UNIT OF THE HETERODYNE INSTRUMENT FOR FIRST: *HIFI*

N. D. Whyborn^a, Th. de Graauw^a, H. van de Stadt^a
V. Belitsky^b, R. Krusinga^c, S. Torchinsky^b, H. Visser^c, K. Wildeman^a

^a Space Research Organisation Netherlands (SRON), PO Box 800, 9700 AV Groningen, The Netherlands

E-mail: nick@sron.rug.NL; Tel: +31 50 363 4074; Fax: +31 50 363 4033

^b Onsala Space Observatory, Chalmers University of Technology, S-412 96 Göteborg, Sweden

^c TNO-TPD, Stieltjesweg 1, 2600 AD Delft, The Netherlands

ABSTRACT

ESA's Far-IR and Sub-millimetre-wave Telescope, *FIRST*, is an astronomy space mission which will provide an unobstructed view of the universe in the last major unexplored region of the electromagnetic spectrum. The satellite is planned to be launched in mid 2006 and will carry a payload of three instruments spanning the wavelength interval 80 and 800 μm . ESA has recently released an Announcement of Opportunity (AO) asking for interested parties to make proposals to provide these instruments and this paper will describe our proposed front-end for a Heterodyne Instrument for FIRST - *HIFI*. *HIFI* will be built by a large consortium of European, American and Canadian institutes which began work defining a heterodyne instrument in 1996.

HIFI will cover the frequency interval 480 - 1250 GHz in 5 bands using pairs of SIS tunnel junction mixers to receive both polarisations. The frequency ranges 1600 - 1900 GHz and 2400 - 2700 GHz will also be covered using single hot-electron bolometer mixers. A modular construction will be used with 6 mixer assemblies, one for each of the 5 lower bands and one for the two high-frequency bands. Each mixer assembly will contain optics for local oscillator injection and the first stage of IF amplification. The local oscillator signals are generated outside the cryostat in a separate unit and pass through dedicated windows in the cryostat wall. The local oscillator unit is described elsewhere. Low noise InP HEMT's with very low power consumption will be used in the IF preamplifiers and will provide a 4 GHz IF bandwidth. A suite of spectrometers in the warm service module of the spacecraft will analyse the IF signals with frequency resolutions ranging from 100 kHz to 1 MHz.

The mixer assemblies slot into a housing containing the optics common to all bands. The common optics performs the functions of refocusing the beam from the telescope, splitting the focal plane amongst the 6 mixer assemblies, chopping, and calibration.

1 INTRODUCTION

The proposed Heterodyne Instrument for FIRST, *HIFI*, has been optimised to address a number of key themes in modern astrophysics related to understanding the cyclical interrelation of stars and the interstellar medium of galaxies. This interplay between stars and the ISM drives the evolution and, thus, the observational characteristics of the Milky Way and other nearby and far away galaxies, all the way back to the earliest protogalaxies at high z .

By combining the high spectral resolving power capability of the radio heterodyne technique with quantum noise limited detection from super-

conductor physics and with the state-of-the-art in microwave technology, *HIFI* will provide unrivalled spectral resolution and ultimate sensitivity over the frequency ranges 480 to 1250 GHz (in 5 bands), 1410 to 1910 GHz, and 2400 to 2700 GHz. The instrument will be able to perform rapid and complete spectral line surveys with resolving powers from 10^3 up to 10^7 (300 - 0.03 km/s) and, will complement the spectroscopy capabilities of the two incoherent instruments on FIRST.

This instrument will fully exploit the recent rapid pace of development in sub-mm wavelength mixer technology to give sensitivity close to the theoretical limit. The first five frequency bands

will each contain a pair of mixers using superconductor-insulator-superconductor (SIS) tunnel junctions. Both polarisations of the astronomical signal will be received for maximum sensitivity. Channel 6 will contain two mixers based on the recently-developed fast hot-electron bolometers (HEB) using thin superconducting films – each mixer will cover one of the sub-bands. The instrument will operate at one frequency at a time, i.e. only one of the frequency bands will be active.

HIFI will have an instantaneous IF bandwidth of 4 GHz analysed in parallel by two types of spectrometers: a pair of wide-band spectrometer (WBS), and a pair of high resolution spectrometer (HRS). The wide-band spectrometer will use acousto-optic technology with a frequency resolution of 1 MHz and a bandwidth of 4 GHz for each of the two polarisations. The HRS will employ either a digital auto-correlation spectrometer (ACS) or a chirp transform spectrometer (CTS) and will provide two combinations of bandwidth and resolution: 1 GHz bandwidth at 200 kHz resolution, and at least 500 MHz at 100 kHz resolution. The HRS will be divided into 4 or 5 sub-bands each of which can be placed anywhere within the full 4 GHz IF band.

HIFI will consist of three major sub-systems and an instrument controller:

1. The focal plane sub-system comprises the focal-plane unit (HFPU) inside the cryostat, containing relay optics, mixers, low-noise IF HEMT pre-amplifiers, a focal plane chopper, and a calibration source; and the HFPU control unit (HFCU) which supplies the bias voltages for the mixers and IF preamplifiers in the HFPU and controls the frequency diplexers, the focal plane chopper mechanism and the calibration source.
2. The local oscillator sub-system comprises: the local oscillator unit (HLOU) located on the outside of the cryostat generating the LO signal which is coupled into the HFPU via a window in the cryostat wall; and the local oscillator control unit (HLCU) in the service module (SVM) which controls the frequency of the local oscillator with a precision of 1 part in 10^8 .
3. A back-end sub-system (HBES) within the SVM. This contains the IF processor, WBS, HRS, and backend control system (BCS).
4. An instrument control unit (HICU) within the SVM which interprets commands from the

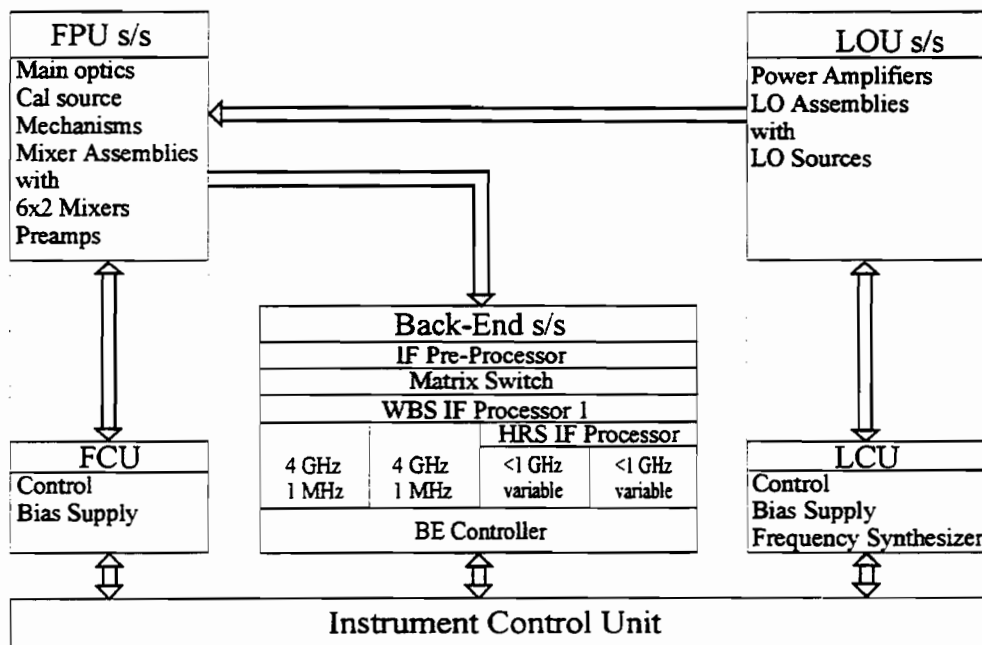

Figure 1. Block diagram of the *HIFI* instrument

satellite telecommand system, controls the operation of the instrument, and returns science and housekeeping data to the satellite telemetry system.

Figure 1 is a block diagram of the *HIFI* showing the relationship between the various units of the instrument.

2 FOCAL PLANE SUB-SYSTEM

2.1 General Description

In the HFPU the sub-mm wavelength signal from the telescope is mixed with radiation from a local oscillator and the "beat frequencies" are generated in a cryogenically cooled mixer. The instrument measures radiation in two polarisations in 5 contiguous bands covering the frequency interval 480 to 1250 GHz and in a single polarisation in two sub-bands around 1.7 THz and 2.5 THz. There are 6 optical beams coming from the telescope, one for each of the 5 dual-polarisation bands and one for the two high-frequency sub-bands.

The HFPU employs a highly modular design consisting of:

- a common optics assembly (COA) which serves as the support structure for the other HFPU modules and contains the optical elements which are common to the 6 optical beams,
- 6 mixer assemblies (MA) containing the optical elements, mixers and IF components specific to each of the 6 instrument bands,
- a chopper assembly containing a nutating mirror and drive mechanism,
- a calibration assembly containing a black-body calibration source and refocusing optics.

These elements are described in the following sections.

Extremely flat and stable spectral baselines are a stringent requirement for the *HIFI* instrument in order to be able to study the very weak broad emission and absorption lines of distant galaxies and to perform broadband spectral surveys. Thus, special emphasis is placed on the design of the optics in the HFPU to avoid generation of standing waves. It also includes a chopper mechanism to switch between two positions on the sky, and will allow the standard dual beam switch techniques for standing wave elimination. In addition, the specification of the intermediate frequency processing from the first IF amplifiers down to the spectrometer backends are driven by these requirements, resulting in particular in the necessity of mounting the first IF amplifiers very close to the mixers (see below) and carefully controlling the thermal environment of critical components with regard to stability.

2.2 Common Optics Assembly

The functions of the instrument optics and their order of implementation are indicated in Figure 2. The first function is calibration (CAL) followed by focal plane chopping (CHOP), band splitting (CHAN), polarisation separation (POL), and LO injection (LO).

The Common Optics Assembly (COA) contains the optics from mirror M3 in the telescope focal plane through to but excluding the Mixer Assemblies (MA) which are described in Section 2.5 (see Figure 3). The COA also includes the calibration assembly.

The telescope focal plane mirror (M3) acts as a folding mirror and also as a field mirror to reduce the optical path length towards the pupil image (= image of the telescope secondary mirror) for packaging reasons. The telescope focal plane is re-imaged in the main optics by means of a Gaussian telescope at unit magnification implemented by a collimating mirror and an imaging mirror, both with a focal length of 280 mm. Between these two

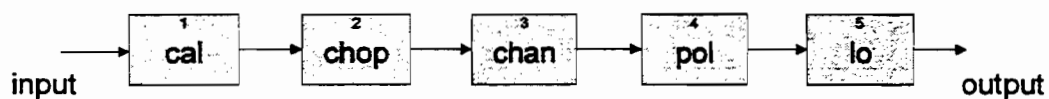

Figure 2. *HIFI* Common Optics functional block diagram

mirrors a flat chopper mirror is positioned in the pupil plane. This mirror implements the second function mentioned above.

After the imaging mirror a flat mirror folds the beam towards a stack of 6 beam splitting mirrors placed at an image of the focal plane. The centres of these mirrors are located on a line oriented perpendicular to the plane shown in Figure 3. These 6 mirrors differ in orientation so that the six resulting beams are separated in direction, thus implementing the function of beam separation. The focal length of the individual band splitting mirrors can be chosen to alter the system exit pupil location while keeping the focal plane image in the same position. Finally the images on the band splitting field mirrors (6x) are re-imaged into the mixer assemblies, which are mounted onto the Main Optics structure in a stack.

The housing of the COA and the mirrors will be machined from a single block of aluminium giving rigidity and dimensional stability. Mirrors will be

bolted to flanges in the housing using 3 fixation points and if necessary shims will be used to adjust the alignment. The mirrors can be added sequentially to allow the alignment to be checked optically at each stage. This construction technique was used very successfully in the Short Wavelength Spectrometer (SWS) flown on ISO.

2.3 The chopper-mechanism

Most observations with *HIFI* will be made using beam switching. A focal plane chopper within the instrument will switch the telescope beam between the astronomical source and a nearby reference position. The spectrometer system will measure the difference in emission between the two positions. The focal plane chopper in *HIFI* will have a beam throw (separation between source and reference position) of 3 arcmin. on the sky and will chop at frequencies up to 1 Hz. The mechanism is similar to the scanning mechanism flown in SWS and LWS on board ISO. The mechanism moves a mirror between three positions: two sky positions

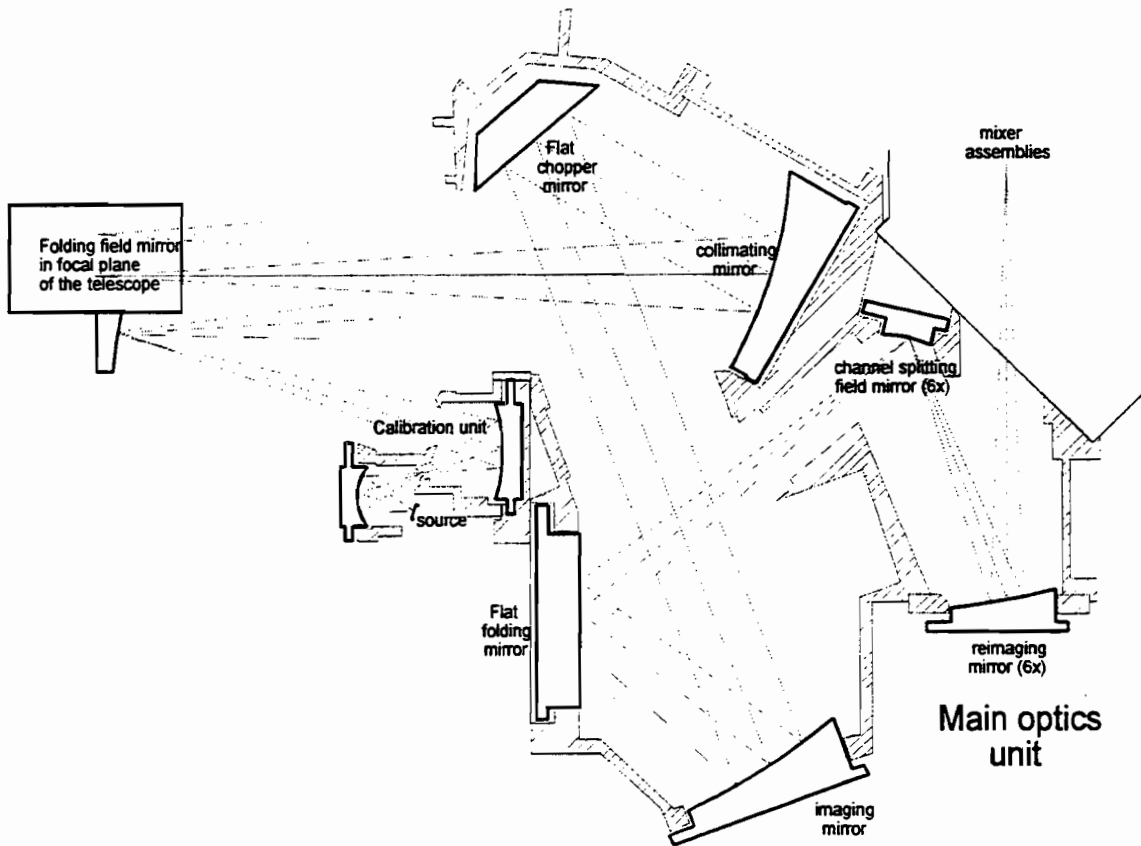

Figure 3. *HIFI* Common Optics layout

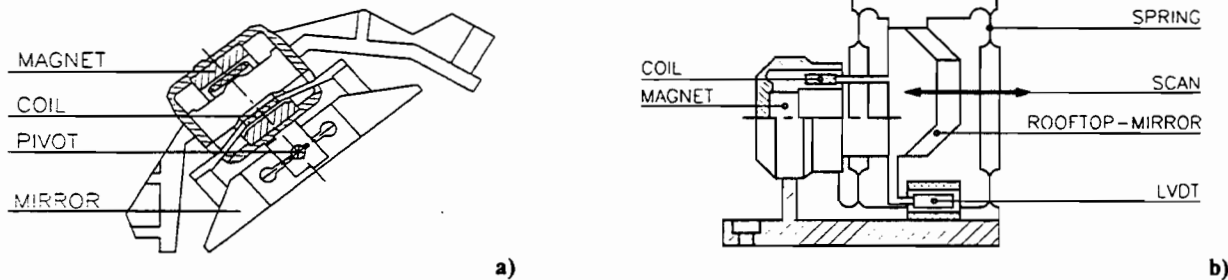

Figure 4. Drawing showing the *HIFI* mechanisms: a) chopper; b) diplexer

and a third calibration position. The required scan angle for the present optical design is 4.6° (pk-to-pk).

The mirror is supported by two flexural pivots. A copper coil carrying a current moving in a radially-oriented magnetic field from SmCo permanent magnets provides the drive force (Figure 4a). The dissipation in the motor coil is estimated to be 0.5 mW on average for square wave chopping of 1 Hz. An LVDT position sensor (also flown on SWS-ISO) provides position feedback for the drive electronics. The dissipation in this sensor is about 0.6 mW.

Because of the vital position of the chopper in *HIFI*, redundant wiring, drive coils and drive electronics will be used for the motor. Additionally, the neutral position of the mechanism will be a sky position allowing *HIFI* to execute most of the scientific observations using telescope position switching and frequency switching in case of failure of the chopper; external astronomical sources would have to be used as calibrators.

2.4 Calibration Assembly

The calibration assembly, located just above the input opening of the main optics housing, provides the instrument with a black body source having an adjustable temperature in the range 15–100 K. This unit couples to the instrument via a part of M3 and is selected for calibration measurements by suitably positioning the chopper mirror. The auxiliary optics in the calibration unit minimises the surface area of the source so as to reduce the heat load on the cryostat.

The goal is to achieve an instrumental calibration accuracy of 3 %. The end-to-end calibration of the system including the telescope will be accomplished by observation of astronomical sources of known strength. The accuracy achieved will depend upon pointing accuracy but should be better than 10 %.

2.5 Mixer Assemblies

The *HIFI* mixers are located in Mixer Assemblies (MA). The MA's contain mechanical supports, mixers, diplexers and polarisers as well as IF amplifiers, and are mechanically mounted on the HFPU. Thermal straps connect the mixers and 1st stages of the IF amplifiers to the "1.7 K level", and the 2nd stage IF amplifier to the "15 K level". A connection to the "4.3 K level" is used to heat-sink an internal wiring harness. A 0.5 K adsorption cooler will be included for the aluminium HEB mixers proposed for band 6.

There will be 6 MA's, each covering a certain frequency range with two mixers, only one MA will operate at any time. The pair of mixers in individual MA's will operate on orthogonal polarisations and are described in Section 2.7.

The optical input to an MA consists of a signal beam and a LO beam. In the MA box the signal beam will be split into 2 polarisations for the 2 mixers. The LO beam will also be split into 2 beams with suitable linear polarisations to be coupled to the mixers. The combining of the signal and LO beams will be by a beamsplitter for the lower frequency two bands, and by tuneable diplexers in the higher bands where less LO power is available. This gives rise to two different optics

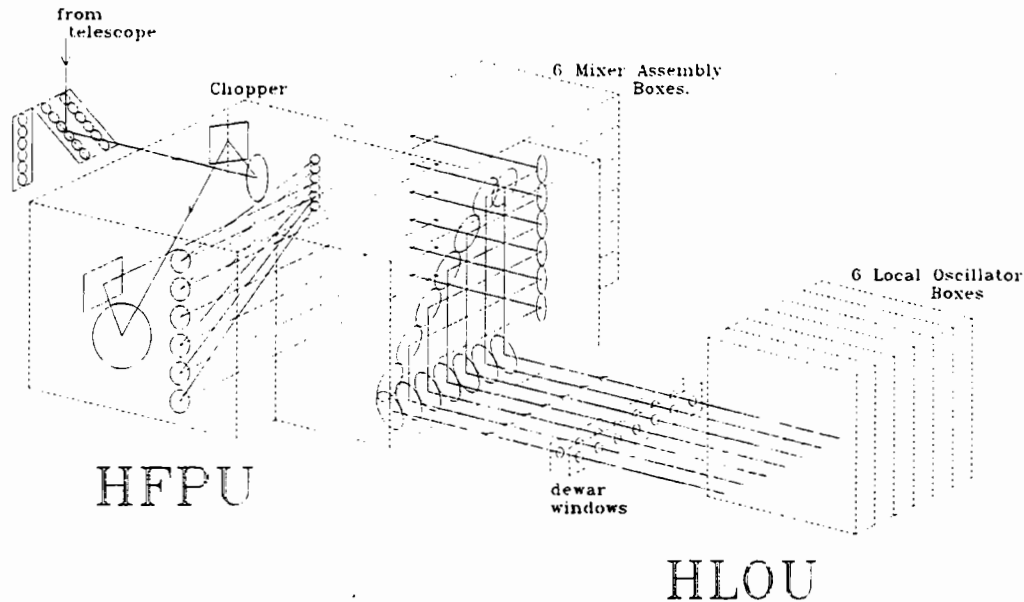

Figure 5. Perspective view showing the LO beam disposition

layouts for the MA boxes, but they will be identical externally.

2.5.1 The Diplexer Mechanisms

The function of the mechanism in the diplexer is to translate a rooftop mirror over about 0.2 mm full stroke. An aluminium rooftop mirror is supported by four leaf springs and driven by a moving coil in a static magnetic field (Figure 4b). A similar mechanical concept was used for the Fabry-Perot mechanism in SWS on ISO. The dissipation is 0.6 mW in the drive coil and about 0.7 mW in the LVDT position sensor. The mechanism is used in bands 3–6 in *HIFI*.

2.5.2 0.5 K Adsorption Cooler

For the 0.5 K level we will include a dedicated ^3He adsorption cooler of a type similar to that flown on IR Telescope in Space (IRTS). This is a sealed device which can provide the necessary small cooling power at 0.5 K and rejects the heat to the "1.7 K level" of the cryostat through a thermal strap. The cooler requires recycling every 48 hours by an electrical heater and when operating will result in a time-averaged dissipation of about 2.4 mW, peak dissipation is expected to be about 50 mW.

2.6 Local Oscillator Optics

The HLOU is located outside the dewar at an optical distance of more than 650 mm from the *HIFI* HFCU. The LO beams are coupled through vacuum windows in the dewar wall and directed into the respective MA's by a set of folding mirrors (Figure 5). We have chosen to use 7 separate sub-windows each optimised for transmission of its LO band. The sub-windows will be small to reduce the thermal load on the cryostat due to radiation and this is accomplished by focusing each beam to a minimum waist at the window location.

2.7 Mixers

Existing technologies for fabricating sensitive heterodyne mixers favour the use of waveguide mixers for the lower frequency bands, while the higher frequencies will use lenses and planar antennas such as double slot lines. However both solutions are compatible with the chosen mechanical and optical configurations.

The proposal for the MA's, mixers and junctions is based on the following assumptions.

- Fixed tuned, double sideband (DSB) mixers in dual polarisation for optimum sensitivity and redundancy.

Table 1. HIFI DSB receiver noise temperature for 3 cases and probable mixer types: (i) State-Of-the-Art Performance (SOAP), (ii) Baseline values and (iii) Goal values. The last column indicates the baseline mixer type: WG – waveguide, QO – quasi-optical.

band	range, GHz	DSB noise temperature, K			mixer technology			mixer type
		SOAP	Baseline	goal	SOAP	Baseline	goal	
1	480	80	70	70	Nb-SIS	Nb-SIS	Nb-SIS	WG
	640	130	110	110				
2	640	130	110	110	„	NbTiN-SIS	NbTiN-SIS	WG
	800	500	150	130				
3	800	500	150	130	„	„	„	WG
	960	700	190	160				
4	960	700	190	160	„	„	„	WG
	1120	1600	230	190				
5	1120	1600	230	190	„	„	„	WG
	1250	1900	510	210				
6a	1410	2100	650	300	Nb-HEB	Nb-HEB	Al-HEB	QO
	1910	2100	650	300				
6b	2400	2500	800	450	„	„	„	QO
	2700	2500	800	450				

- Continuous frequency coverage of 480–1250 GHz split into 4 sub-bands of 160 GHz bandwidth and one of 130 GHz with an overlap of 2 GHz between bands.
- 2 sub-bands covering 1410–1910 GHz and 2400–2700 GHz without dual polarisation.

The proposed frequency bands, sensitivities and foreseen detector types are given in Table 1. Sensitivity values are given for three cases: (i) presently achieved values with state-of-the-art performance (SOAP); (ii) Baseline values to be achieved after the development years from 1998 to 2000; (iii) Goal values, expected to be achievable after further improvements before delivery of the

FM in 2004. The use of new detector materials such as NbTiN makes the expected improvement in sensitivity possible.

The SIS mixers need an adjustable magnetic field of a few hundred Gauss which is provided by small superconducting electromagnet coils. These magnets are integrated in or close to the mixers. To occasionally remove unwanted trapped flux from the junction, a heater resistor, either on chip or close to the chip, is used to warm up the mixer chip just beyond the superconducting transition temperature of the SIS junction materials momentarily. The HEB mixers of band 6 do not need a magnetic field.

Table 2. Cryogenic IF preamplifier performance

Centre frequency	10 GHz for SIS mixers, 4 GHz for HEB mixers	IF system noise temperature	10 K – baseline 5 K – goal
Bandwidth	4 GHz	Passband ripple	± 1.5 dB
IF power level at SVM	-90 ± 5 dBmW/MHz	Amplitude non- linearity	< 1 %

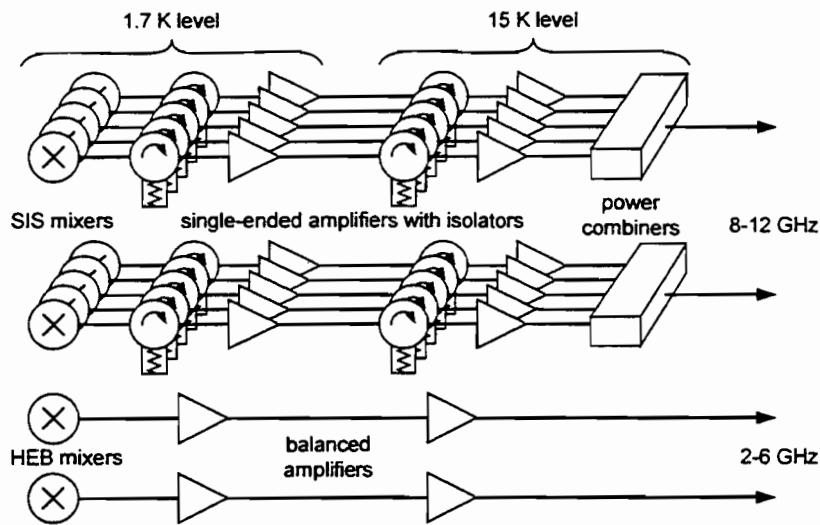

Figure 6. Block diagram of IF pre-amplification scheme.

2.8 IF Preamplifiers

The function of the IF preamplifiers of the *HIFI* instrument is to amplify the IF signals from the mixers with the minimum of additional noise. Other aims are to achieve flat gain over the band, low power dissipation, stability and reliability. The IF preamplifiers will be as close as possible to the mixers and operate at 1.7 K to maximise sensitivity. The preamplifier outputs will be connected to the IF processor in the SVM by coaxial cables in the spacecraft cryoharness. One mixer assembly with two mixers and their associated IF preamplifiers, one set for each polarisation, will operate at a time. A summary of the cryogenic IF system is given in Table 2.

The basic IF pre-amplification scheme is shown in Figure 6. Each mixer is followed by a dedicated IF

preamplifier – 6 bands times 2 polarisations giving 12 preamplifiers in total. For the SIS mixers of bands 1 to 5, these operate with an IF of 10 GHz, while band 6 will use HEB mixers and have an IF centre frequency of 4 GHz. Since only one pair of mixers will operate at any time, we propose to use power combiners to feed the signals from bands 1 to 5 into a single pair of coaxial cables – the choice of band is made by activation of the required pair of preamplifiers. The IF signals from band 6 will be fed into a second pair of IF cables. This reduces the number of coaxial cables between the front-end and the IF processor to four, with a consequent reduction in thermal load.

Cryogenic isolators at 1.7 K will be used to suppress reflections between the mixers and 10 GHz preamplifiers, but balanced amplifiers will be necessary for the 2-6 GHz band. Fixed

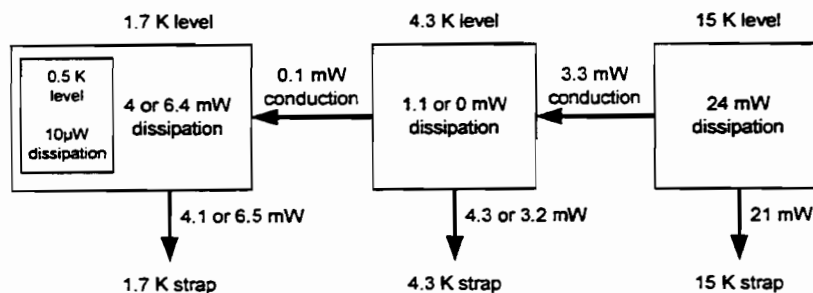

Figure 7. Diagram showing the HFPU thermal interface with the spacecraft.

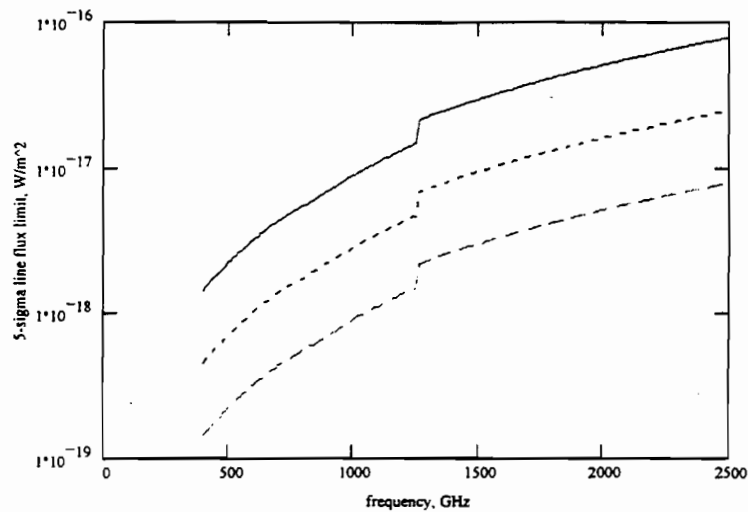

Figure 8. 5-sigma point-source line flux detection limits for a 1 hour integration and for three velocity resolutions starting from the top: 300, 30, and 3 km/s

attenuators after each preamplifier will be used to set the correct IF output levels and band-pass filters in each chain will suppress out-of-band signals.

A total IF gain of 38 dB or more is required in the HFPU to overcome cable and other losses and to render the noise contribution of the back-end system insignificant. To avoid problems with feedback and instability the desired amplification will be achieved by a cascade of two amplifiers. The baseline is to cool the 1st stages of the IF preamplifiers to 1.7 K with the second stages operating at 15 K where there is a higher heat-lift capacity. An option to integrate the first preamplifier stage into the mixer to obtain the maximum possible sensitivity will be studied. If the cooling capability at 1.7 K is insufficient for the expected 4 mW dissipation of the 1st stages of the preamplifier, then a back-up option is to operate them at 4.3 K.

2.9 Focal Plane Unit Control Electronics

The Focal plane unit Control Unit (HFCU) will contain electronics to perform the following functions:

- control the mechanisms, the calibration source, and the 0.5 K adsorption cooler,

- provide suitable bias voltages and currents to the mixers, mixer magnets, de-flux heaters and IF preamplifiers,
- interface with the Instrument Controller Unit (HICU) to allow it to control all functions and to return housekeeping data.

The digital interface controller forms the heart of the HFCU. Implemented in an FPGA or ASIC, it will communicate with the HICU via balanced serial digital interfaces. It will store in volatile memory all settings relevant to the above functions, as received from the HICU. These settings will be fed to D/A converters, thus generating reference levels that are translated into accurate mechanism positions, bias currents/voltages or temperature levels. The HFCU will also periodically recycle the 0.5 K adsorption cooler by passing current through a heater.

The HFCU will also contain a data acquisition system to collect analogue housekeeping information on all relevant parameters of HFCU and HFPU: mechanism positions, bias current/voltage, temperature levels etc. This analogue housekeeping circuitry will include signal conditioning (filtering, amplification), multiplexing and A/D conversion. The HFCU will also provide digital housekeeping: information on unit status and settings. All housekeeping

information will be available to the HICU upon request, through the interface controller.

The HFCU will obtain secondary power from a dedicated section of the DC/DC converter in the HICU. In order to support stand-by and sleep modes, parts of the HFCU electronics can be switched off.

2.10 Thermal Interface

The thermal interface of the HFPU is shown schematically in Figure 7. The housing, optical components, and 2nd stage IF preamplifiers are cooled to 15 K by thermal straps to the S/C. There is only limited heat transfer from the HFPU housing to the optical table. A strap to the 4.3 K level provides a heat-sink for the cables to the mixers. The SIS mixers operate at 1.7 K being cooled by a strap to the helium tank. Heat rejected from the 0.5 K adsorption cooler is also removed through a strap to the 1.7 K level.

3 PREDICTED PERFORMANCE

We present the baseline observing performance of *HIFI* for three illustrative cases: a deep, point-source integration, a frequency survey, and mapping is shown below. We have not made any allowance for calibration and other overheads.

3.1 Deep Integration

For this case taking a spectral resolution of $R=10^4$ (30 km/s velocity resolution), 1 hour integration time gives the 5σ flux detection limits shown in Figure 8.

3.2 Line survey

In Table 3 we list the expected $1-\sigma$ noise levels for a complete 24-hour line survey over various frequency intervals and at a resolution of 1 MHz.

3.3 Mapping

In Table 4 we list the expected speed in mapping a region to the given noise levels using the on-the-fly technique.

Table 3. Spectrum $1-\sigma$ noise level for 24 hour line survey at 1 MHz resolution

Frequency range	spectrum $1-\sigma$ noise level
480-1250 GHz	18 mK
1410-1900 GHz	52 mK
2400-2700 GHz	73 mK

Table 4. The mapping speed in arcmin² per hour to achieve the stated noise level in a fully sampled map

Frequency, GHz	noise level, $\sigma T^*/K$	mapping speed / (arcmin ² hr ⁻¹)
500	0.1	530
1000	0.3	290
2500	1	41

4 SUMMARY

We have described the focal plane unit of *HIFI* as proposed for FIRST. According to the current mission schedule, the instrument will be launched at the end of 2005 and will provide the first high resolution view of the sub-mm universe unaffected by absorption in the Earth's atmosphere.

5 ACKNOWLEDGEMENT

We gratefully acknowledge the contributions of the following people:

- M. Carter, K-F. Schuster: IRAM, France.
- G. Beaudin, M. Gheudin, M. Salez: Observatoire de Paris, France.
- F. Lura, G. Schwaab: DLR Berlin, Germany.
- K. Jacobs, C. Honingh, R. Schieder, J. Stutzki: Köln University, Germany.
- P. Zimmermann: Radiometer Physics, Germany.
- A. Murphy: St. Patrick's College Maynooth, Ireland.
- E. Natale: CNR Firenze, Italy.
- R. Orfei: Frascati, Italy.
- D.A. Beintema, J.R. Gao, B-J. van Leeuwen: SRON, The Netherlands.
- J.D. Gallego-Puyol, J. Martin-Pintado: Centro Astronomico Yebes, Spain.
- J.P. Starksy: Chalmers Univ. of Technology, Sweden.
- S. Withington: MRAO Cambridge, UK.
- B. Ellison, D. Matheson: RAL, UK.
- T. Phillips, J. Zmuidzinas: CALTECH, USA.
- N. Erickson: FCRAO UMass, USA.
- T.C. Gaier, R. McGrath, J.C. Pearson: JPL Pasadena, USA.