

GOLD HILL
EST. — 1859
ELEV. — 8463
POP. — 118
TOTAL 10440

**Code
Generation
Super
Lectures**

Huge One-Slide Summary

- **Assembly language** is untyped, unstructured, low-level and imperative. In a **load-store** architecture, **instructions** operate on **registers** (which are like global variables). The **stack pointer** is a special-purpose register.
- We can **generate code** by targeting a **stack machine** and using assembly instructions to implement the stack. The stack holds intermediate values, temporaries, and function arguments. The **accumulator** register (conceptually, the top of the stack) holds the result of the last computation. As an **invariant**, the stack is unchanged by intermediate calculations.
- We will maintain a **stack discipline** (or **calling convention**). Each function call is represented on the stack by an **activation record** (or **stack frame**). The activation record contains the **frame pointer**, the **parameters**, the **self** object pointer, the **return address**, and space for **temporaries**. The code you generate for function calls and function bodies must consistently agree on the calling convention.
- Our **object layout** choice must support using a subtype whenever a supertype is expected. Objects are **contiguous** blocks of memory that hold bookkeeping information (e.g., type tags, method pointers) as well as space for **fields**. **Subobjects** will **extend** (be bigger than in memory) their superobjects and will **share a common prefix**.
- A **dispatch table** (or **virtual function** table or **vtable**) is an array of pointers to methods. Each object points to its vtable, and members of a class **share** one vtable. This allows us to implement **dynamic dispatch**: method invocation is resolved by looking up the method address in the object's vtable at **runtime**.

(Two Day) Lecture Outline

- Stack machines
 - e.g., Java Virtual Machine
- The COOL-ASM assembly language
 - It's MIPS/RISC + Java Bytecode
- A simple source language
- Stack-machine implementation of the simple language
- An optimization: stack-allocated variables
- Object Oriented Code Generation
 - Object Layout, Dynamic Dispatch

Stack Machines

- A simple evaluation model
- No variables or registers
- A stack of values for intermediate results



Example

Stack Machine Program

- Consider two instructions
 - `push i` - place the integer `i` on top of the stack
 - `add` - pop two elements, add them and put the result back on the stack
- A program to compute $7 + 5$:
 - `push 7`
 - `push 5`
 - `add`

Stack Machine Example

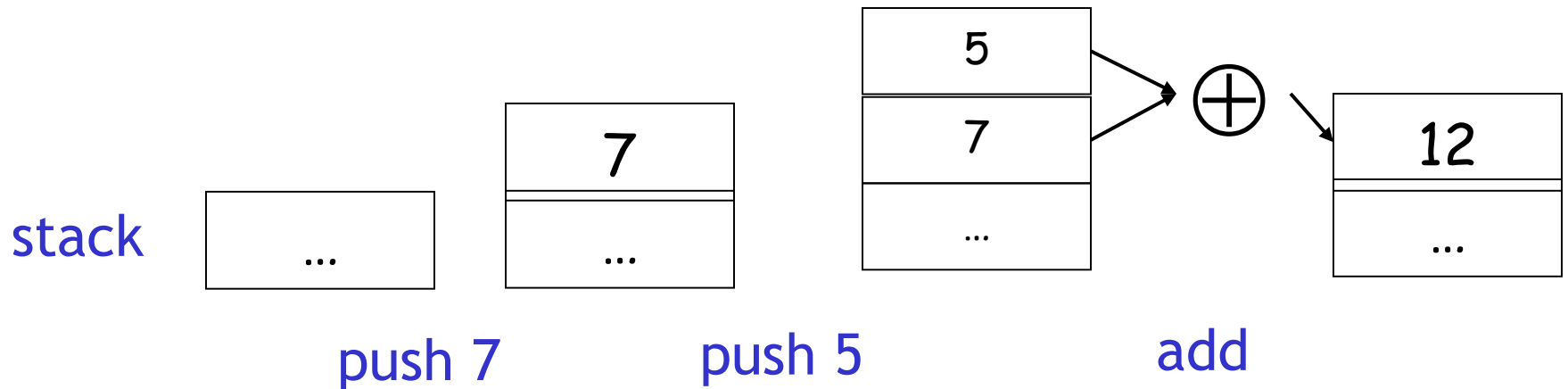

- Each instruction:
 - Takes its operands from the top of the stack
 - Removes those operands from the stack
 - Computes the required operation on them
 - Pushes the result on the stack

Why Use a Stack Machine ?

- Each operation takes operands from the same place and puts results in the same place
- This means a uniform compilation scheme
- And therefore a simpler compiler
 - This is the easiest way to do CA4
 - The reference compiler is more complicated

Why Use a Stack Machine ?

- Location of the operands is implicit
 - Always on the top of the stack
- No need to specify operands explicitly
- No need to specify the location of the result
- Instruction “**add**” as opposed to “**add** r_1 , r_2 ”
 - ⇒ Smaller encoding of instructions
 - ⇒ More compact programs (= faster: why?)
- This is one reason why Java Bytecodes use a stack evaluation model

Optimizing the Stack Machine

- The add instruction does 3 memory operations
 - Two reads and one write to the stack
 - The top of the stack is frequently accessed
- Idea: keep the top of the stack in a register (called the **accumulator**)
 - This should remind you of **Fold**
 - Register accesses are faster
- The “**add**” instruction is now
$$\text{acc} \leftarrow \text{acc} + \text{top_of_stack}$$
 - Only one memory operation!

Fear my course organization!

Accumulator Invariants

- The result of computing an expression is always in the accumulator
- For an operation $op(e_1, \dots, e_n)$ **push** the accumulator on the stack after computing each of e_1, \dots, e_{n-1}
 - e_n 's result is in the accumulator before **op**
 - After the operation **pop** $n-1$ values
- After computing an expression the stack is as before

Example on next slide!

Stack Machine with Accumulator: Example

- Compute $7 + 5$ using an accumulator

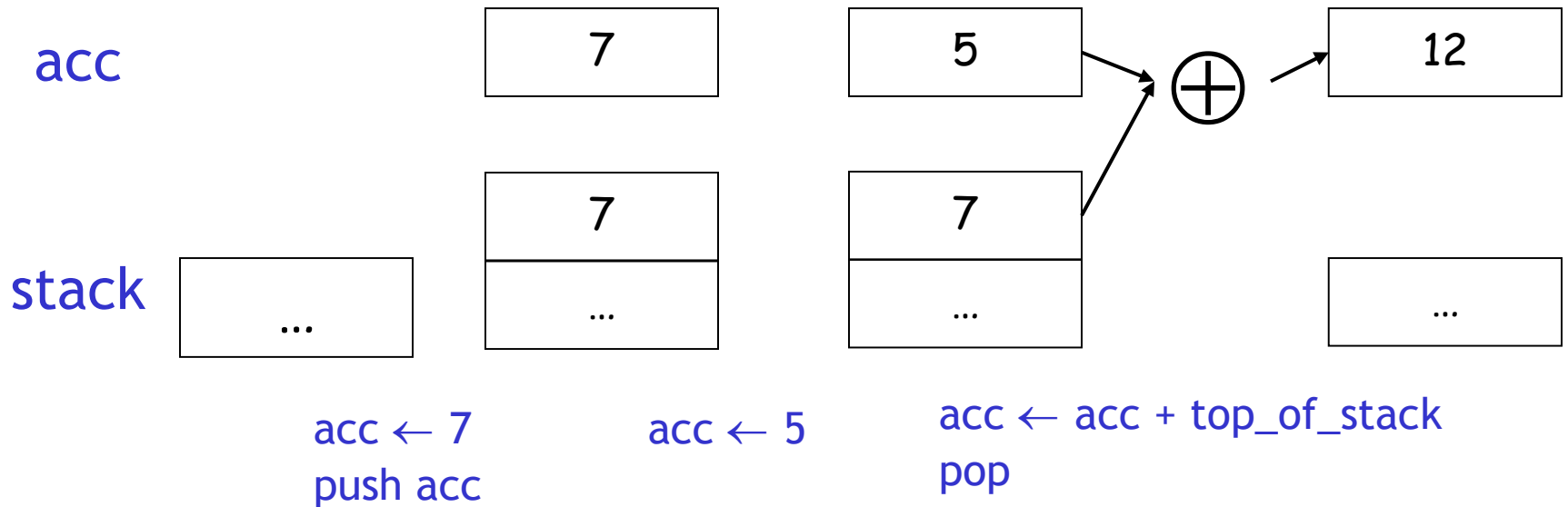

A Bigger Example: $3 + (7 + 5)$

Code	Acc	Stack
<code>acc ← 3</code>	3	<init>
<code>push acc</code>	3	3, <init>
<code>acc ← 7</code>	7	3, <init>
<code>push acc</code>	7	7, 3, <init>
<code>acc ← 5</code>	5	7, 3, <init>
<code>acc ← acc + top_of_stack</code>	12	7, 3, <init>
<code>pop</code>	12	3, <init>
<code>acc ← acc + top_of_stack</code>	15	3, <init>
<code>pop</code>	15	<init>

Notes

- It is **critical** that **the stack is preserved across the evaluation of a subexpression**
 - Stack before evaluating $7 + 5$ is $3, <init>$
 - Stack after evaluating $7 + 5$ is $3, <init>$
 - The first operand is on top of the stack

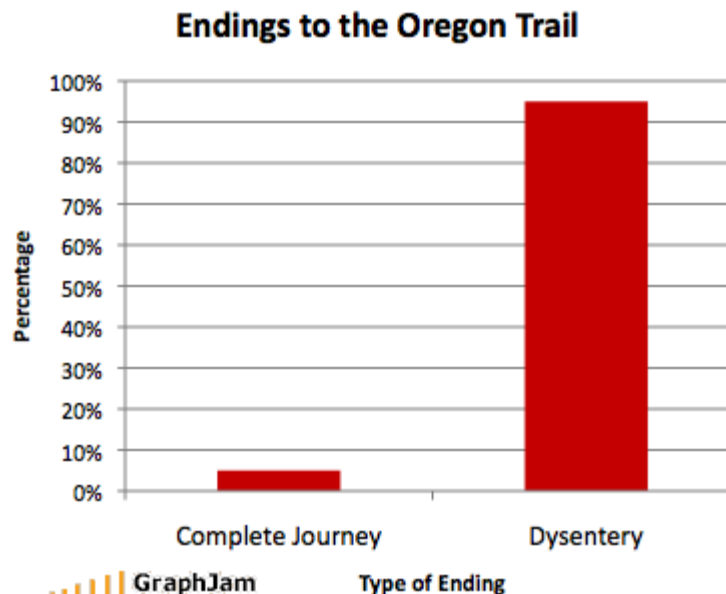

From Stack Machines to RISC

- Our compiler will generate code for a stack machine with accumulator
- We want to run the resulting code on a processor
- We'll implement stack machine instructions using COOL-ASM instructions and registers
- Thus: Assembly Language



Risky Business

- COOL-ASM is a RISC-style **assembly language**
 - An untyped, unsafe, low-level, fast programming language with few-to-no primitives.
- A **register** is a fast-access untyped global variable shared by the entire assembly program.
 - COOL-ASM: 8 general registers and 3 special ones (stack pointer, frame pointer, return address)
- An **instruction** is a primitive statement in assembly language that operates on registers.
 - COOL-ASM: add, jmp, ld, push, ...
- A **load-store** architecture: bring values in to registers from memory to operate on them.

Drink Your Cool-Aid

- Sample COOL-ASM instructions:

- See the CRM for all of them ...

add r2 <- r5 r2 ; r2 = r5 + r2

li r5 <- 183 ; r5 = 183

ld r2 <- r1[5] ; r2 = *(r1+5)

st r1[6] <- r7 ; *(r1+6) = r7

my_label: -- dashdash also a comment

push r1 ; *sp = r1; sp --;

sub r1 <- r1 1 ; r1 -- ;

bnz r1 my_label ; if (r1 != 0) goto my_label



Simulating a Stack Machine...

- The **accumulator** is kept in register **r1**
 - This is just a convention. You could pick **r2**.
- The stack is kept in memory
- The stack **grows towards lower addresses**
 - Standard convention on the MIPS architecture
- The address of the next unused location on the stack is kept in register **sp**
 - The top of the stack is at address **sp + 1**
 - COOL-ASM “Word Size” = 1 = # of memory cells taken up by one integer/pointer/string

Trivia: CS History

(kab9rm memorial)

- This operating system was first developed in the 1970's by Dennis Ritchie, Ken Thompson, and others at Bell Labs. It supported multiple users and multiple tasks running on the same machine (often the 16-bit PDP 11 available from DEC). Innovations include the “everything is a file” philosophy, pipelines and filters of small utility processes, and shell scripting of workflows. It was the first portable OS, developed almost entirely in C.

Trivia: Computer Scientists

- This US Navy Rear Admiral is credited with inventing the first compiler for a computer programming language, as well as popularizing machine-independent languages. The term “debugging” also originates here:

9/9

0600 Antan started

1000 stopped - antan ✓

1300 (033) MP-MC 2.13047645

033) PRO 2 2.13047645

convd. 2.13067645

Relays 6-2 in 033 failed speed test
in relay. 11.00 test.

1100 Started Cosine Tape (Sine check)

1525 Started Multi-Adder Test.

1545  Relay #70 Panel F
(moth) in relay.

1700 First actual case of bug being found.
Antan started.
1700 closed down.

Relay 3145
Relay 3376

Cool Assembly Example

- The stack-machine code for $7 + 5$:

`acc <- 7`

`push acc`

`acc <- 5`

`acc <- acc + top_of_stack`

`pop`

`li r1 7`

`sw sp[0] <- r1`

`sub sp <- sp 1`

`li r1 5`

`lw r2 <- sp[1]`

`add r1 <- r1 r2`

`add sp <- sp 1`

- We now generalize this to a simple language...

Stack Instructions

- We have these COOL-ASM instructions:

push rX

```
st sp[0] <- rX
```

```
sub sp <- sp 1
```

pop rX

```
ld rX <- sp[1]
```

```
add sp <- sp 1
```

; Note:

rX <- top

```
ld rX <- sp[1]
```

A Small Language

- A source language with integers and integer operations

$P \rightarrow D; P \mid D$

$D \rightarrow \text{def id(ARGS) = E;}$

$\text{ARGS} \rightarrow \text{id, ARGS} \mid \text{id}$

$E \rightarrow \text{int} \mid \text{id} \mid \text{if } E_1 = E_2 \text{ then } E_3 \text{ else } E_4$
 $\mid E_1 + E_2 \mid E_1 - E_2 \mid \text{id}(E_1, \dots, E_n)$

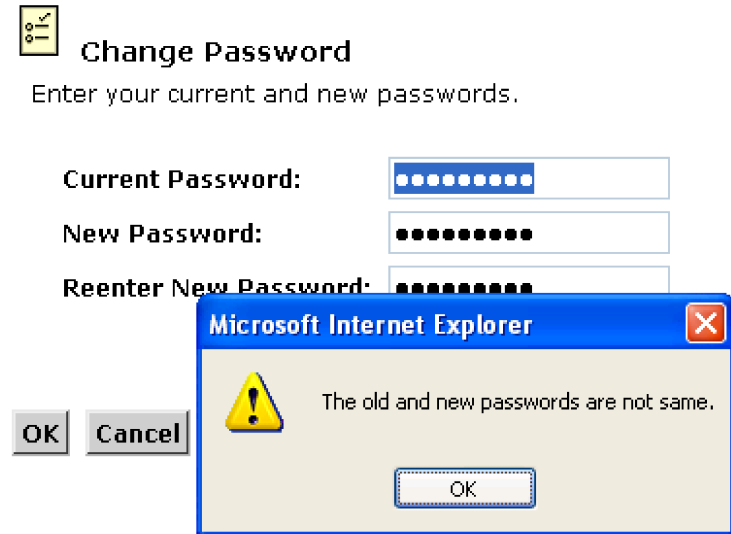

A Small Language (Cont.)

- The first function definition f is the “main” routine
- Running the program on input i means computing $f(i)$
- Program for computing the Fibonacci numbers:

```
def fib(x) = if x = 1 then 0 else
             if x = 2 then 1 else
             fib(x - 1) + fib(x - 2)
```

Code Generation Strategy

- For each expression e we generate COOL-ASM code that:
 - Computes the value of e in $r1$ (accumulator)
 - Preserves sp and the contents of the stack
- We define a **code generation function** $cgen(e)$ whose result is the code generated for e

Code Generation for Constants

- The code to evaluate a constant simply copies it into the accumulator:

cgen(123) = li r1 123

- Note that this also preserves the stack, as required



Code Generation: Add

$\text{cgen}(e_1 + e_2) =$

$\text{cgen}(e_1)$

push r1

$\text{cgen}(e_2)$

;; e2 now in r1

pop t1

add r1 t1 r1

t1 is some
unused
“temporary”
register

- Possible optimization: Put the result of e_1 directly in register $t1$?

Code Generation Mistake

- Unsafe Optimization: put the result of e_1 directly in $t1$?

```
cgen( $e_1 + e_2$ ) =  
cgen( $e_1$ )  
mov t1 <- r1  
cgen( $e_2$ )  
add r1 <- t1 r1
```

- Try to generate code for : $3 + (7 + 5)$



Code Generation Notes

- The code for $+$ is a template with “holes” for code for evaluating e_1 and e_2
- Stack-machine code generation is **recursive**
- Code for $e_1 + e_2$ consists of code for e_1 and e_2 glued together
- Code generation can be written as a **recursive-descent tree walk** of the AST
 - At least for expressions

Code Generation: Sub

- New instruction: `sub reg1 <- reg2 reg3`
 - Implements $reg_1 \leftarrow reg_2 - reg_3$

cgen(e₁ - e₂) =

`cgen(e1)`

`push r1`

`cgen(e2)`

`pop t1`

`sub r1 <- t1 r1`



Code Generation: If

- We need flow control instructions
- New instruction: **beq reg₁ reg₂ label**
 - **Conditional Branch** to label if $reg_1 = reg_2$
- New instruction: **jmp label**
 - **Unconditional Jump** to label

Code Generation for If (Cont.)

```
cgen(if  $e_1 = e_2$  then  $e_3$  else  $e_4$ ) =  
  cgen( $e_1$ )  
  push r1  
  cgen( $e_2$ )  
  pop t1  
  beq r1 t1 true_branch ;; else fall through  
  cgen( $e_4$ )  
  jmp end_if  
true_branch:  
  cgen( $e_3$ )  
end_if:
```

Trivia: Beatles & Skyrim

(alb4dx memorial)

- This lonely 1966 hit from the album Revolver features a double string quartet arrangement, making it distinct from standard popular music at the time. The eponymous character wears a “face that she keeps in a jar by the door”.
- Name the two main military factions in Tamriel, one of which suppresses religious freedom (banning the worship of Talos as per the White Gold Concordant surrender treaty to the Altmer) and one of which is quite racist (see the Grey Quarter of Windhelm and “Skyrim belongs to the Nords!”) and secessionist.

The Activation Record

- An **activation record** (or **stack frame**) stores calling context information on the stack during a function call.
- Code for function calls/definitions depends on the layout of the activation record
- A very simple AR suffices for this language:
 - The result is always in the accumulator
 - No need to store the result in the AR
 - The activation record holds actual parameters
 - For $f(x_1, \dots, x_n)$ push x_1, \dots, x_n on the stack
 - These are the only variables in this language

Calling Convention

- This **calling convention** (or **stack discipline**) guarantees that on function exit **sp** is the same as it was on entry
 - No need to save **sp**
- We need the return address
- It's handy to have a pointer to start of the current activation
 - This pointer lives in register **fp** (frame pointer)
 - Reason for frame pointer will be clear shortly

The Activation Record

- Summary: For this language, an AR with the caller's frame pointer, the actual parameters, and the return address suffices
- Picture: Consider a call to $f(x,y)$. The AR will be:

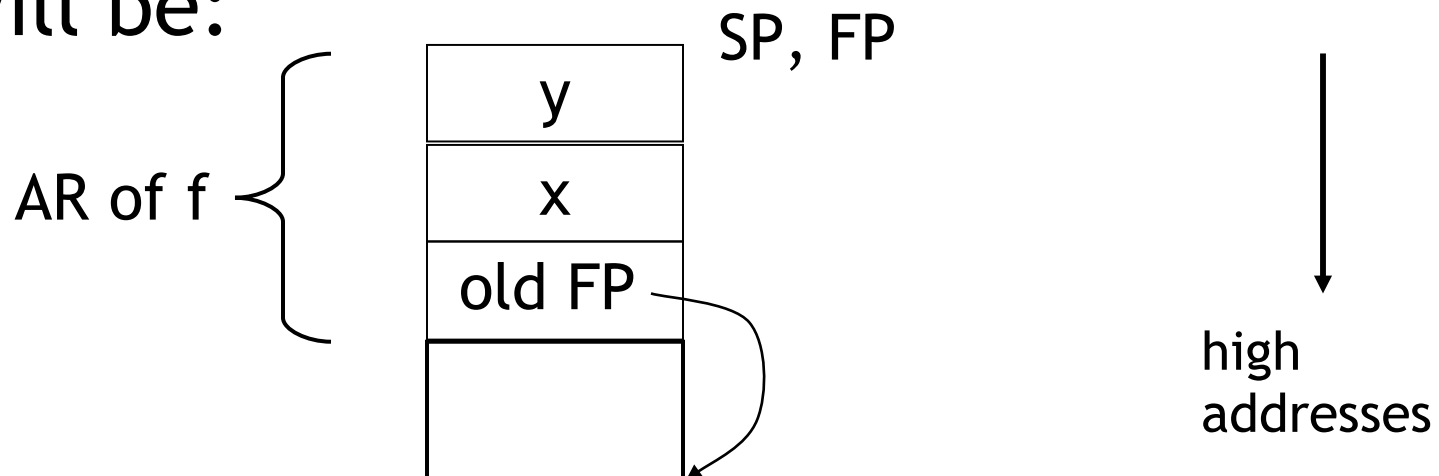

Code Generation: Function Call

- The **calling sequence** is the instructions (of both caller and callee) to set up a function invocation
- New instruction: **call label**
 - Jump to label, save address of next instruction in **ra**
 - On other architectures the return address is stored on the stack by the “call” instruction
 - (This is also called “branch and link”.)

Code Generation: Function Call

cgen(f(e₁,...,e_n)) =

push fp

cgen(e₁)

push r1

...

cgen(e_n)

push r1

call f_entry

pop fp

- The caller saves its value of the frame pointer
- Then it saves the actual arguments in order
- The caller saves the return address in register **ra**
- The AR so far is **n+1** bytes long
- Caller restores **fp**

Code Generation: Function Def

- New instruction: **return**
 - Jump to address in register **ra**

cgen(def f(x₁,...,x_n) = e) =

f_entry:

mov fp <- sp

push ra

cgen(e)

ra <- top

add sp <- sp z

return

- Note: The frame pointer points to the top, not bottom of the frame
- The callee pops the return address, the actual arguments and the saved value of the frame pointer
- **z = n + 2** (so far)

Calling Sequence: $f(x,y)$

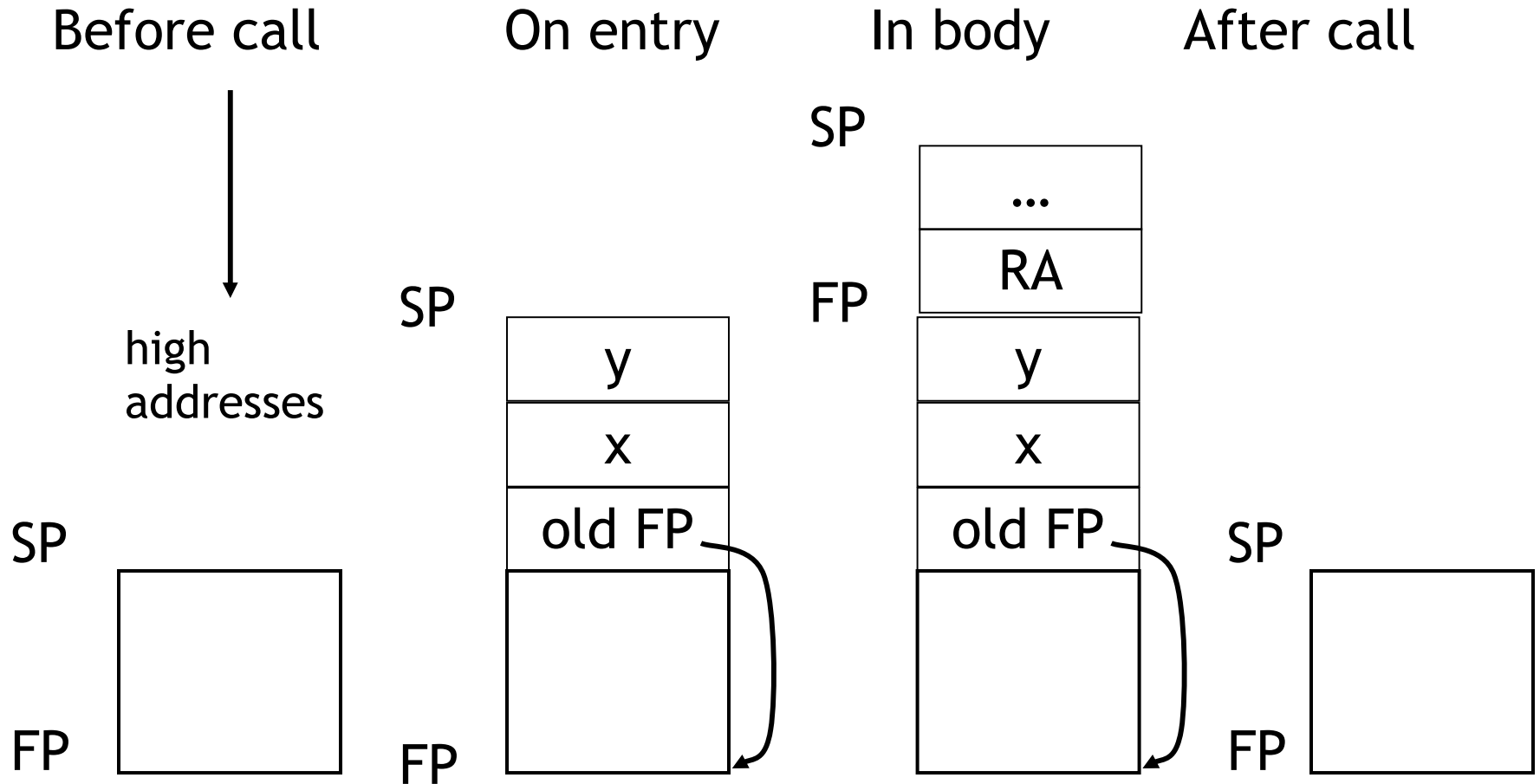

Code Generation: Variables

- Variable references are the last construct
- The “variables” of a function are just its parameters
 - They are all in the AR
 - Pushed by the caller
- Problem: Because the stack grows when intermediate results are saved, the variables are not at a fixed offset from `sp`
 - Impress me: what are they a fixed offset from?

Code Generation: Variables

- Solution: use the **frame pointer**
 - Always points to the return address on the stack (= the value of sp on function entry)
 - Since it does not move it can be used to find arguments stored on the stack
- Let x_i be the i^{th} ($i = 1, \dots, n$) formal parameter of the function for which code is being generated

Code Generation: Variables

- Example: For a function `def f(x1,x2) = e` the activation and frame pointer are set up as follows:

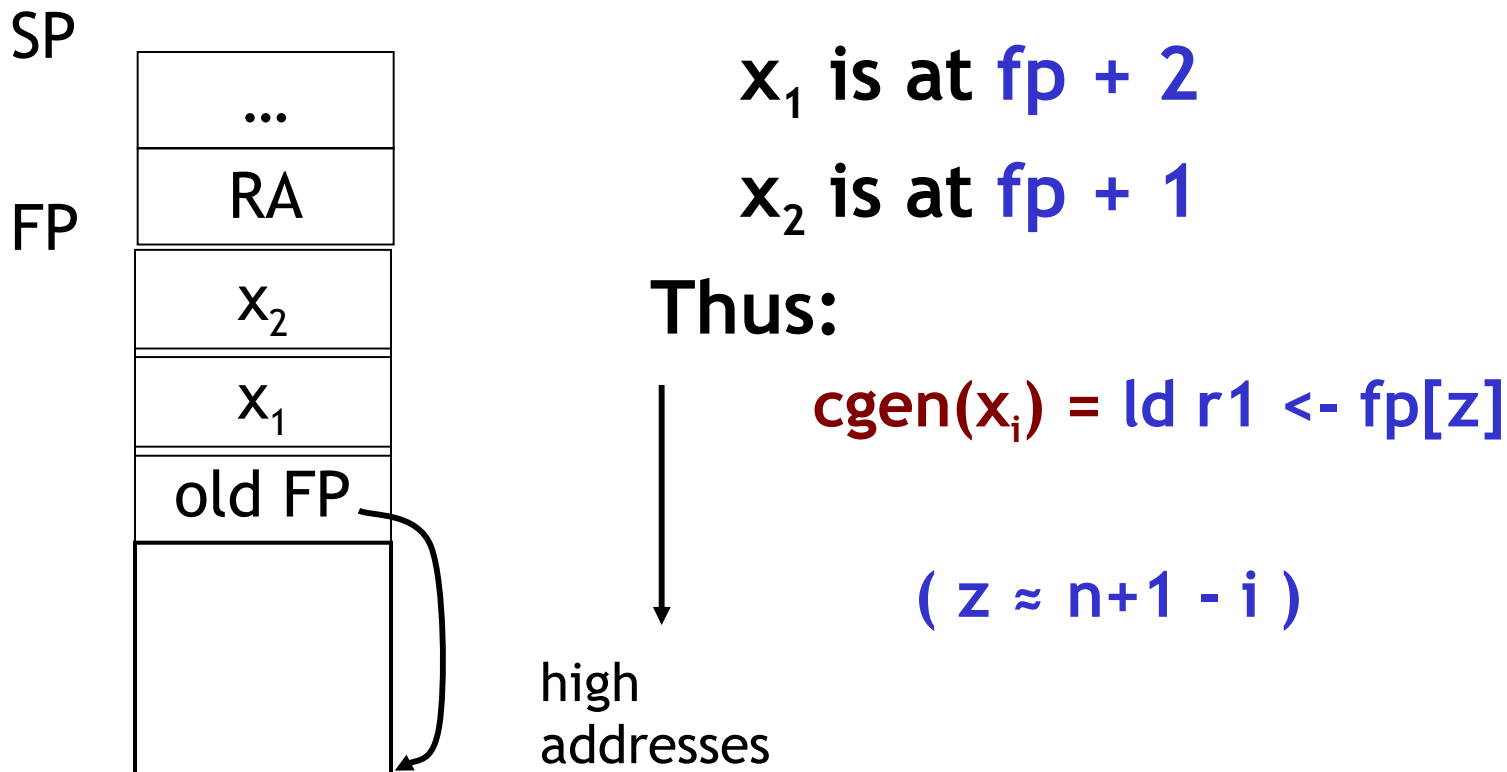

Summary

- The activation record must be designed together with the code generator
- Code generation can be done by recursive traversal of the AST
- We recommend you use a stack machine for your Cool compiler (it's simple)

More Information

- use cool `--asm hello-worl.cl` for examples
- Production compilers do different things
 - Emphasis is on keeping values (esp. current stack frame) in registers
 - Intermediate results are laid out in the AR, not pushed and popped from the stack



Optimization: Allocating Temporaries in the Activation Record



Review

- The stack machine code layout we've described so far has activation records and intermediate results interleaved on the stack

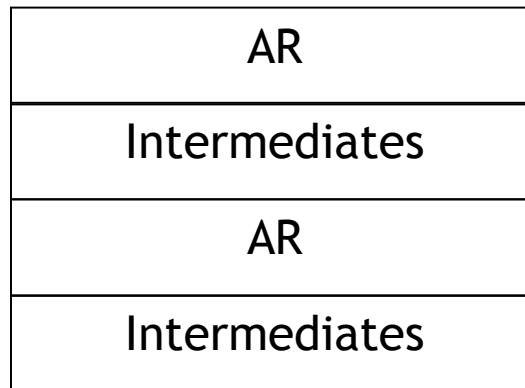

Stack Machine Implications

- Advantage: Very simple code generation
- Disadvantage: **Very slow code**
 - Storing and loading temporaries requires a store/load and **sp** adjustment

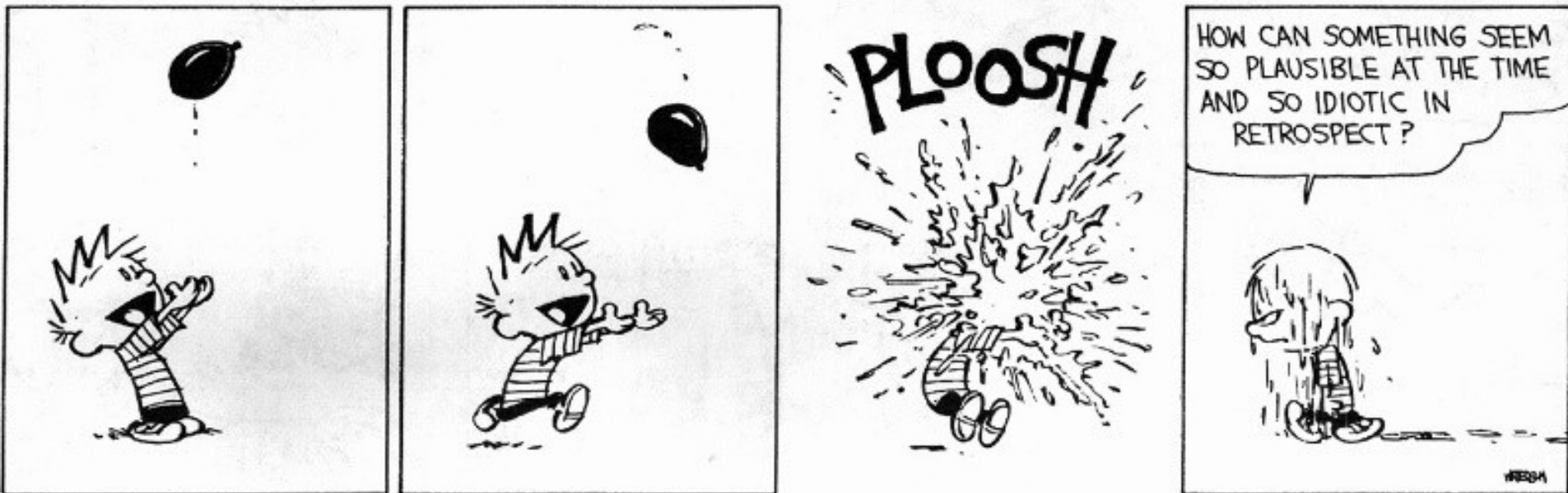

A Better Way

- Idea: Keep temporaries in the AR
- Work: The code generator must assign space in the AR for each temporary



Example

```
def fib(x) = if x = 1 then 0 else  
            if x = 2 then 1 else  
            fib(x - 1) + fib(x - 2)
```

- We must determine:
 - What intermediate values are placed on the stack?
 - How many slots are needed in the AR to hold these values?

Trivia: Physics

(igs3pw memorial)

- Rosalind Franklin and Raymond Gosling's famous “Photo 51” is an X-ray diffraction image of the structure of *what*? James Watson was shown the photo without Franklin's approval; along with Francis Crick, Watson used the photo to develop a particular chemical model. Franklin died in 1958 while Watson and Crick were awarded a Nobel Prize in Physiology or Medicine in 1962.

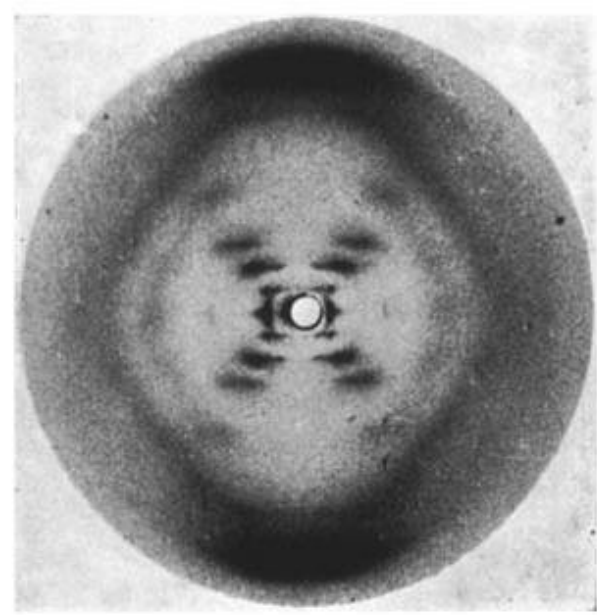

How Many Temporaries?

- Let $NT(e)$ = # of temps needed to eval e

- Example: $NT(e_1 + e_2)$

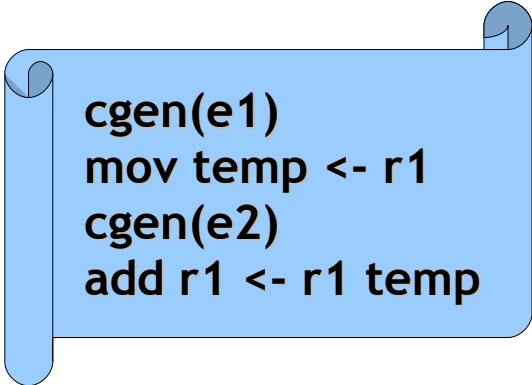

```
cgen(e1)
mov temp <- r1
cgen(e2)
add r1 <- r1 temp
```

- Needs at least as many temporaries as $NT(e_1)$
 - Needs at least as many temporaries as $NT(e_2) + 1$
- Space used for temporaries in e_1 can be reused for temporaries in e_2

The NumTemps Equations

$$\text{NT}(e_1 + e_2) = \max(\text{NT}(e_1), 1 + \text{NT}(e_2))$$

$$\text{NT}(e_1 - e_2) = \max(\text{NT}(e_1), 1 + \text{NT}(e_2))$$

$$\text{NT}(\text{if } e_1 = e_2 \text{ then } e_3 \text{ else } e_4)$$

$$= \max(\text{NT}(e_1), 1 + \text{NT}(e_2), \text{NT}(e_3), \text{NT}(e_4))$$

$$\text{NT}(\text{id}(e_1, \dots, e_n)) = \max(\text{NT}(e_1), \dots, \text{NT}(e_n))$$

$$\text{NT}(\text{int}) = 0$$

$$\text{NT}(\text{id}) = 0$$

Is this bottom-up or top-down? (you tell me)

What is $\text{NT}(\dots\text{code for fib}\dots)$?

The Revised AR

- For a function definition $f(x_1, \dots, x_n) = e$ the AR has $2 + n + NT(e)$ elements (so far)
 - Return address
 - Frame pointer
 - n arguments
 - $NT(e)$ locations for intermediate results



Stack Frame Picture

$$f(x_1, \dots, x_n) = e$$

SP

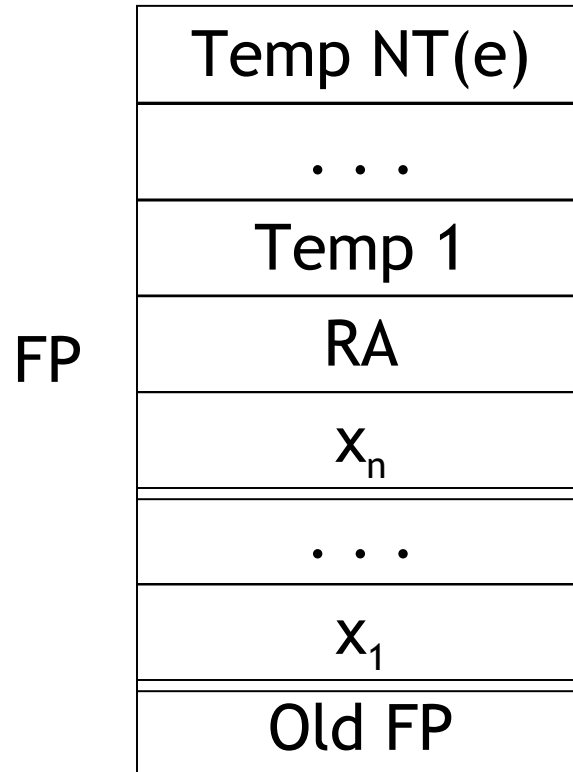

FP

↓
high
addresses

Revised Code Generation

- Code generation must know how many temporaries are in use at each point
- Add a new argument to code generation: the position of the next available temporary

`cgen(e, n)` : generate code for `e` and use temporaries whose address is `(fp - n)` or lower

Code Generation for +

$\text{cgen}(e_1 + e_2) =$
 $\text{cgen}(e_1)$
 push r1
 $\text{cgen}(e_2)$
 pop temp
 add r1 <- r1 temp

$\text{cgen}(e_1 + e_2, nt) =$
 $\text{cgen}(e_1, nt)$
 st fp[-nt] <- r1
 $\text{cgen}(e_2, nt+1)$
 ld temp <- fp[-nt]
 add r1 <- r1 temp

Where are the savings?

Hint: “push” is more expensive than it looks.

Notes

- The temporary area is used like a small, fixed-size stack
- Exercise: Write out `cgen` for other constructs
- Hint: on function entry, you'll have to increment something by $NT(e)$
 - ... and on function exit, decrement it ...

Code Generation for Object-Oriented Languages



Object Layout

- OO implementation =
 - Stuff from before + More stuff
- **Liskov Substitution Principle**: If B is a subclass of A, then an object of class B can be used wherever an object of class A is expected
- This means that code in class A **must work unmodified** on an object of class B

Two Issues

- How are objects represented in memory?
- How is dynamic dispatch implemented?



Object Layout (Cont.)

- An object is like a `struct` in C. The reference `foo.field` is an index into a `foo` struct at an offset corresponding to `field`
- Objects in Cool are implemented similarly
 - Objects are laid out in contiguous memory
 - Each attribute stored at a fixed offset in object
 - When a method is invoked, the object becomes `self` and the fields are the object's attributes

Cool Object Layout

- The first 3 words of Cool objects contain header information:

	<i>Offset</i>
Class Type Tag	0
Object Size	1
Dispatch / Vtable Ptr	2
Attribute 1	3
Attribute 2	4
...	

(This is a convention that we made up, but it is similar to how Java and C++ lay things out. For example, you could swap #1 and #2 without loss.)

Cool Object Layout

- **Class tag** (or “**type tag**”) is a raw integer
 - Identifies class of the object (Int=1, Bool=2, ...)
- **Object size** is an integer
 - Size of the object in words
- **Dispatch pointer** (or “**vtable pointer**”) is a pointer to a table of methods
 - More later
- **Attributes** are laid out in subsequent slots
- The layout is contiguous

Object Layout Example

```
Class A {
```

```
  a: Int <- 0;
```

```
  d: Int <- 1;
```

```
  f(): Int { a <- a + d };
```

```
};
```

```
Class B inherits A {
```

```
  b: Int <- 2;
```

```
  f(): Int { a }; // Override
```

```
  g(): Int { a <- a - b };
```

```
};
```

```
Class C inherits A {
```

```
  c: Int <- 3;
```

```
  h(): Int { a <- a * c };
```

```
};
```

Object Layout (Cont.)

- Attributes **a** and **d** are inherited by classes **B** and **C**
- All methods in all classes refer to **a**
- For **A** methods to work correctly in **A**, **B**, and **C** objects, attribute **a** must be in the same “place” in each object

Subclass Layout

Observation: Given a layout for class **A**, a layout for subclass **B** can be defined by **extending** the layout of **A** with additional slots for the additional attributes of **B**

(i.e., append new fields at bottom)

Leaves the layout of **A** unchanged

(**B** is an extension)

Object Layout Picture

```
Class A {  
  a: Int <- 0;  
  d: Int <- 1;  
  f(): Int { a <- a + d };  
};
```

```
Class B inherits A {  
  b: Int <- 2;  
  f(): Int { a }; // Override  
  g(): Int { a <- a - b };  
};
```

Class	A	B	C
Offset			
0 (tag)	Atag	Btag	Ctag
1 (size)	5	6	6
2 (vtable)	*	*	*
3 (attr#1)	a	a	a
4 ...	d	d	d
5		b	c

```
Class C inherits A {  
  c: Int <- 3;  
  h(): Int { a <- a * c };  
};
```

Subclasses (Cont.)

- The **offset for an attribute** is the **same** in a class and all of its subclasses
 - This choice allows any method for an A_1 to be used on a subclass A_2
- Consider layout for $A_n \leq \dots \leq A_3 \leq A_2 \leq A_1$

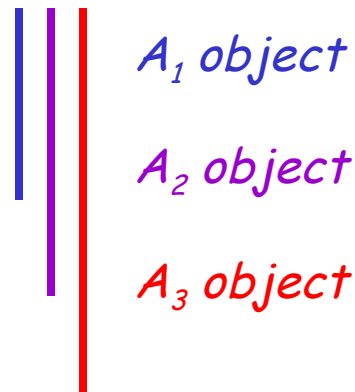
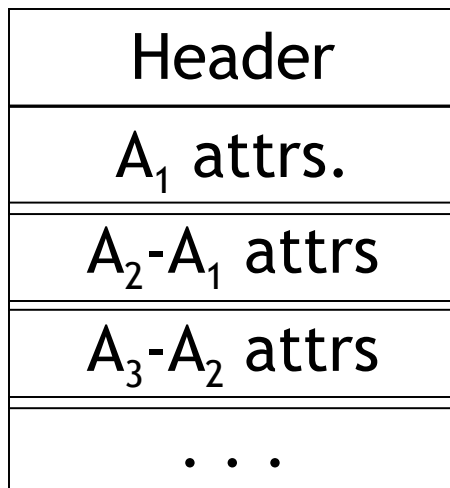

*Extra Credit:
What about
multiple
inheritance?*

Dynamic Dispatch

- Consider **f** and **g**:

```
Class A {  
  a: Int <- 0;  
  d: Int <- 1;  
  f(): Int { a <- a + d };  
};
```

```
Class B inherits A {  
  b: Int <- 2;  
  f(): Int { a }; // Override  
  g(): Int { a <- a - b };  
};
```



```
Class C inherits A {  
  c: Int <- 3;  
  h(): Int { a <- a * c };  
};
```

Dynamic Dispatch Example

- `e.g()`
 - `g` refers to method in `B` if `e` is a `B`
- `e.f()`
 - `f` refers to method in `A` if `f` is an `A` or `C`
(inherited in the case of `C`)
 - `f` refers to method in `B` for a `B` object
- The implementation of methods and dynamic dispatch strongly resembles the implementation of attributes

Dispatch Tables

- Every class has a fixed set of methods (including inherited methods)
- A **dispatch table** (or **virtual function table** or **vtable**) indexes these methods
 - A vtable is an array of method entry points
 - (Thus, a vtable is an array of function pointers.)
 - A method **f** lives at a **fixed offset** in the dispatch table for a class **and all of its subclasses**

Dispatch Table Example

Class	A	B	C
Offset			
0	f_A	f_B	f_A
1		g	h

- The dispatch table for class **A** has only 1 method
- The tables for **B** and **C** extend the table for **A** with more methods
- Because methods can be overridden, the method for **f** is not the same in every class, but is always at the same offset
 - (i.e., offset 0 here)

Using Dispatch Tables

- The dispatch pointer in an object of class X points to the dispatch table for class X
 - i.e., all objects of class X **share** one table
- Every method f of class X is assigned an offset O_f in the dispatch table at compile time
 - i.e., by you in PA6 when you're generating the assembly code

A Sense of Self

- Every method must know what object is “self”
 - Convention: **“self” is passed as the first argument** to all methods
- To implement a dynamic dispatch $e.f()$ we
 - Evaluate e , obtaining an object x
 - Find D by reading the dispatch-table field of x
 - Call $D[O_f](x)$
 - D is the dispatch table for x
 - In the call, $self$ is bound to x

Dynamic Dispatch Hint

- To reiterate: objexp.mname(arg1)
 - push self
 - push fp
 - cgen(arg1)
 - push r1 ; push arg1
 - cgen(objexp)
 - bz r1 dispatch_on_void_error
 - push r1 ; will be “self” for callee
 - ld temp <- r1[2] ; temp <- vtable
 - ld temp <- temp[X] ; X is offset of mname in vtables
 - ; for objects of typeof(objexp)
 - call temp
 - pop fp
 - pop self

“Extra Credit”: Multiple Inheritance



Example

- Assume that we extend Cool with multiple inheritance
- Consider the following 3 classes:

```
Class A { a : Int; m1() : Int { a }; }
```

```
Class B { b: Int; m2() : Int { b }; }
```

```
Class C inherit A, B { c : Int; m2() : Int { c }; }
```

- class C inherits attribute a and method m1 from A, attribute b from B and overrides m2

Multi-Inherit Object Layout

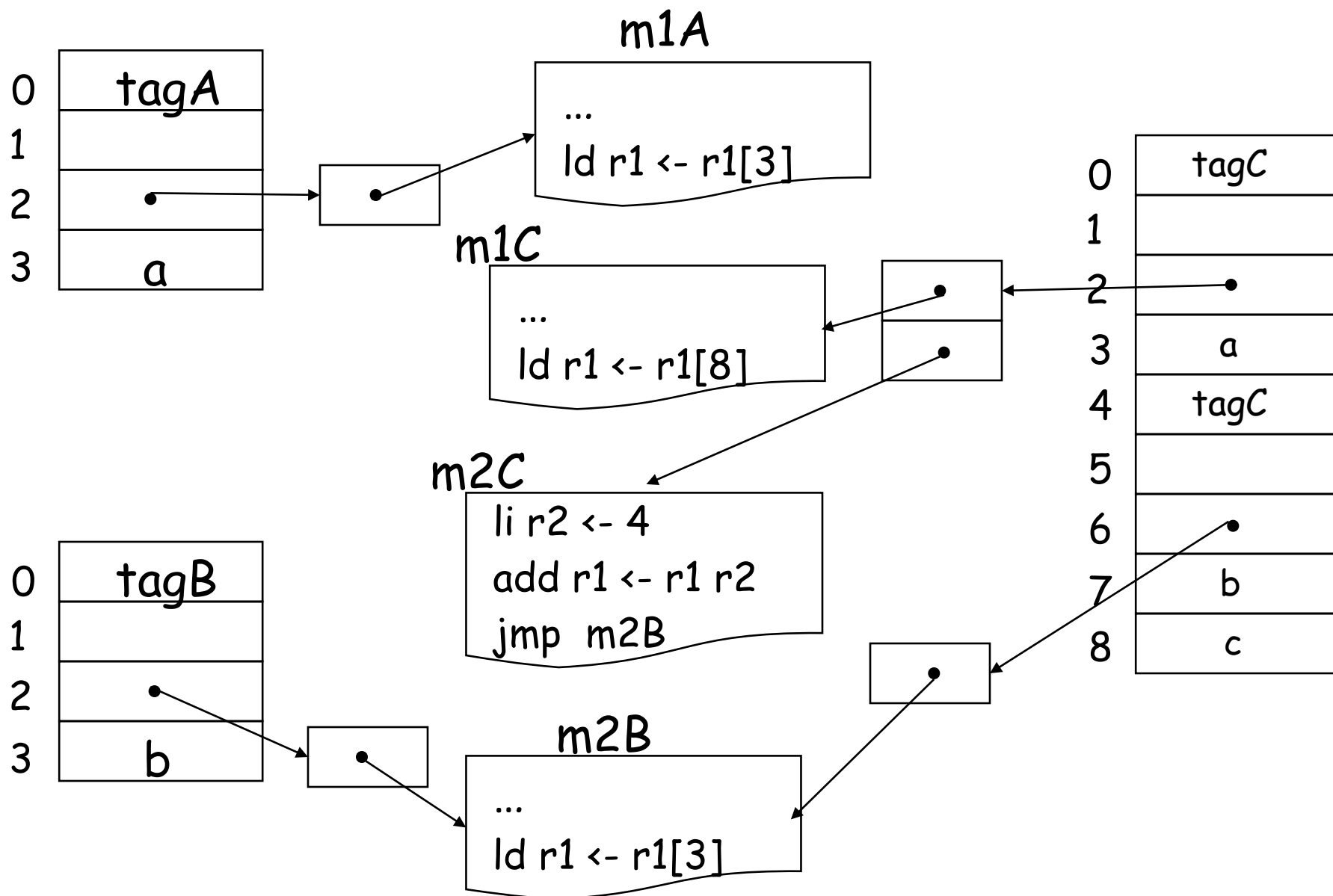

Homework

- PA3 (Parsing) Due
- CA2 (Three-Address) Due
- RS3 Recommended