

# Experiences with a High-Fidelity Wireless Building Energy Auditing Network

Xiaofan Jiang, Minh Van Ly, Jay Taneja, Prabal Dutta, and David Culler  
Computer Science Division  
University of California, Berkeley

{fxjiang, mvly, taneja, prabal, culler}@cs.berkeley.edu

## Abstract

We describe the design, deployment, and experience with a wireless sensor network for high-fidelity monitoring of electrical usage in buildings. A network of 38 mote-class AC meters, 6 light sensors, and 1 vibration sensor is used to determine and audit the energy envelope of an active laboratory. Classic WSN issues of coverage, aggregation, sampling, and inference are shown to appear in a novel form in this context. The fundamental structuring principle is the underlying load tree, and a variety of techniques are described to disambiguate loads within this structure. Utilizing contextual metadata, this information is recomposed in terms of its spatial, functional, and individual projections. This suggests a path to broad use of WSN technology in energy and environmental domains.

## Categories and Subject Descriptors

H.4 [Information Systems Applications]: General; B.4 [Input/Output and Data Communications]: General

## General Terms

Design, Experimentation, Measurement, Performance, Human Factors

## Keywords

Energy, Audit, Building, Power, Wireless, Sensor Networks

## 1 Introduction

Annual U.S. electricity consumption has tripled in the past two decades and recent reports estimate that 72% of the total U.S. electricity consumption occurs in residential and commercial buildings [28] and that 30% of energy consumed in buildings is *wasted* [29]. To reduce this waste, building occupants and facilities managers need to better understand how buildings use energy, broken down over space and time, by function, and per-individual.

Today, however, energy usage statistics are usually available only in the aggregate: typically monthly but sometimes in 15 minute intervals and usually at the level of a building but occasionally at the level of a circuit. Although building- and circuit-level meters can provide *full coverage* of electrical power usage, in that all loads are accounted for, they do not provide *detailed coverage*, in that visibility into the consumption of individual loads is rarely available. Significant and sustainable reductions in energy usage will require more detailed visibility into consumption than is available today.

Electricity, unlike many other phenomena observed using sensornets, flows along a tree-shaped distribution network or *load tree*. In an ideal world, we would have *full* and *detailed* coverage of the load tree. Not only would we have fine-grained access to total electricity usage – instrumentation at the root of the tree – but we would also have access to the usage of every load – instrumentation at every leaf in the load tree – including every laptop, light bulb, refrigerator, microwave, compressor, server, printer, and fax machine. Unfortunately, it is implausible to meter every leaf in practice. In this paper, we explore several practical techniques for approximately disaggregating the load tree using a relatively sparse set of carefully-placed sensors.

While disaggregating the load tree provides unprecedented insight into fine-grained electricity usage, understanding how, where, and for whom loads use electricity requires exploring several additional questions. Answering *how* electricity is used – for example by lighting, heating, computing, or cooling – requires classifying loads by their function or type, either manually or automatically. Answering *where* electrical power is used requires projecting measurements taken on the load tree onto physical space. Finally, answering the question *for whom* the lights flicker requires tracking people, their occupancy in space, and their interactions with things.

In this paper, we analyze an accessible portion of a typical computer science department as a case study in energy monitoring. Our study focuses on a laboratory that occupies one-third of a floor and explores several techniques for approximating the ideal load tree for maximum coverage at minimum cost. We begin by analyzing the structure of the load tree and by building a comprehensive inventory of appliances and loads at the various levels of the tree. We then deploy a relatively sparse network of heterogeneous plug-load meters and light sensors at carefully chosen sampling points,

and collect data continuously over several months. The data are collected at a rate of one sample per minute per sensor over a multihop wireless network. Using this unprecedented data set, we explore several techniques for modeling, estimating, and disaggregating energy usage across functional, spatial, user, and signal domains.

## 2 Related Work

Research has shown that visibility into the energy consumption of homes and offices can result in 5-20% reductions in electricity usage [11, 10]. However, the current level of visibility in buildings is insufficient – energy consumption data are often delayed, difficult to access, and aggregated. Stern has shown that real-time, per-appliance visibility provides substantially greater utility and more actionable information [27]. Unfortunately, this level of sensing coverage historically has been difficult to achieve.

There has been a tremendous amount of research and industrial effort in recent years that has made significant strides toward providing greater visibility. The MIT *Plug* [22] power meter platform provides high-fidelity apparent power measurements, which is useful for profiling a load over short and long time scales. Multi-modal sensing has also been explored in the literature [9]. A significant amount of work has also been shown recently in industry towards improving building energy monitoring. Several startups, such as Tendril [7], Greenbox [3], and EnergyHub [4], have introduced ZigBee Home Profile-based wireless energy monitoring solutions. These products take a bottom-up approach by providing detailed power measurements of selected individual loads. While this approach is useful in observing a few loads at high fidelity, it is neither practical nor cost-effective when full coverage of tens or hundreds of appliances is desired. The area of wireless sensor networks has also made significant progress in this application space. For example, Sentiilla [6] offers a data center energy monitoring solution that uses wireless plug-load meters and interoperates with other types of sensors. Arch Rock [1] offers a sub-monitoring solution for commercial buildings that uses wireless branch level meters. Kim et. al. have developed methods to infer power usage using non-intrusive means such as magnetic sensors [18], and proposed a framework to profile personal resource consumption using a combination of resource monitoring and activity monitoring [17].

An opposite approach is to place the sensing instrument at the root of the power distribution network, or *load tree*, and use algorithms to increase visibility by disambiguating an aggregated load from the top down. For example, many utility companies have introduced AMI programs that provide near-real-time visibility into the aggregate energy consumption of homes. Some utilities are partnering with aggregators such as the Google PowerMeter [2] project and the Microsoft Hohm [5] project to provide a rich visual feedback of user energy usage at the household level. Some utilities have incorporated “bill disaggregation” web applications that break down users’ monthly bills by disaggregating the different types of loads from their aggregated energy traces. This type of approach was originally proposed by Hart in 1992 [15]. He proposed disaggregating individual electrical loads based

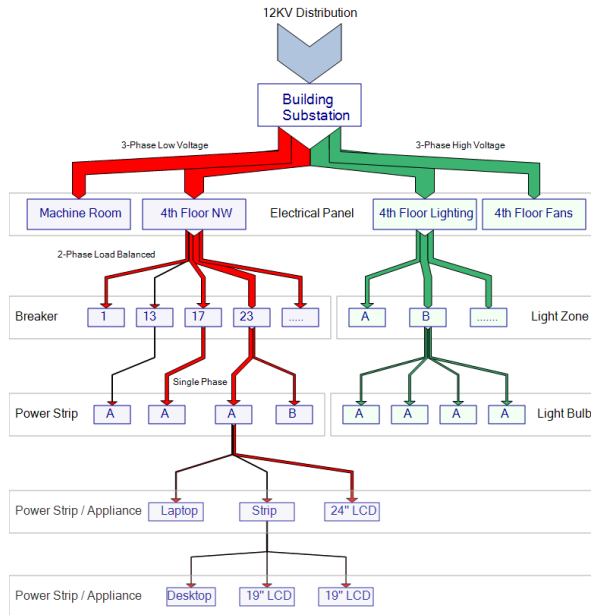

**Figure 1. Snapshot of a small portion of the load tree in a computer science building. Voltage is stepped down from the building substation into floor-level electrical panels which in turn distribute power into either AC outlets in the low-voltage case or lights and major equipments in the high-voltage case.**

on real and reactive power measurements. The approach is feasible for a small number of loads that have distinguishable differences in power factor. Norford et al. improved this method with event detection to help disambiguate appliances with similar reactive and real power signatures. More complex algorithms have been developed and have shown improvements [19], [14], [26], [8], [20], [21], [24]. However, this approach is generally less effective in an office environment in which many loads are based on switched power supplies, such as desktops, laptops, and LCD screens.

In this work, we deploy a wireless energy monitoring network close to the appliances, but we also deploy a small number of wireless energy meters at aggregated measurement points as well, in order to collect empirical high fidelity data over large extents of space and time. We analyze this data and present our experiences in dissecting the load tree and improving energy consumption coverage.

## 3 Load Tree

Energy is distributed through a building as various sub-flows in a tree-like structure – the *load tree* – as shown in Figure 1. Visibility into the load tree is fundamental to understanding how energy is distributed and used within a building. In an ideal world, we would have *full and detailed* coverage of the load tree by directly monitoring not only the root of the tree, but also every single load at the leaves of the tree. However, this is rarely possible. In reality, people are often faced with a tradeoff between full coverage and detailed but partial coverage. A small number of instrumen-

tation points close to the root of the tree provides a complete, albeit aggregated, picture of the entire building. This level of visibility is common for many buildings, and is an appropriate extent of coverage for most building managers. Appliance-level metering such as that provided by plug-load meters provides detailed power profiles of individual loads. This level of visibility is appropriate for understanding the energy consumption at the appliance level.

To ground the discussion in the remainder of this paper, we review key aspects of the load tree used in our case study. The load tree begins at the root where a single high-voltage power line connects the building to its parent substation. This line delivers power to the entire building. The incoming power is typically stepped-down into several high and low voltage lines, distributing 3-phase AC power into sets of electrical panels across multiple floors. The low voltage panels distribute 120V/208V 3-phase power and the high voltage panels distribute 277V/480V 3-phase power. Panels are normally divided by location and function. For example, in Figure 1, there are two low voltage panels, one for the machine room and one for supplying all the AC outlets in the north-west region of the 4th floor. There are also two high voltage panels, one for all the overhead lights and one for the fans.

From the panels, 3-phase power is fanned out into multiple 2-phase or 3-phase breakers, depending on need. In our example, the northwest region panel splits into thirty 2-phase breakers, with each breaker supplying multiple single-phase AC outlets (labeled as power strips), spread throughout the physical space in a balanced fashion. Power strips are chained to establish more levels in the load tree. The lighting panel fans out into multiple light zones in which all lights in the same zone are turned on and off simultaneously, using one or more switches. Within a particular light zone, light bulbs of varying wattages are combined together to provide an appropriate lighting level.

#### 4 Energy Monitoring Network

Load Type	Count
Laptops	39
Desktops	28
LCDs	68
Projectors	3
Refrigerators	1
Coffee makers	1
Phones	3
Desk lamps	5
Network switches	6
Printers	4
Microwaves	1
Total appliances:	159
Total AC outlets:	340

**Table 1. Inventory of appliances within the energy monitoring network. A subset of these outlets and appliances were instrumented.**

We instrument a laboratory inside the computer science building at the authors’ institution that spans an area of 63

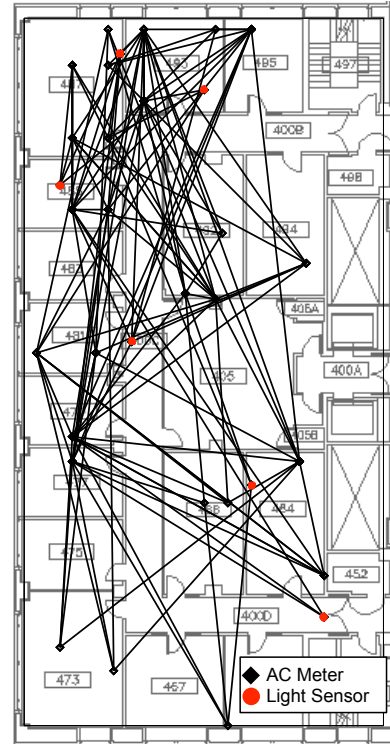

**Figure 2. Location and connectivity graph of AC meters and light sensors. There are a total of 38 AC meters, 28 of which are spatially distinct, and 6 light sensors. The vibration sensor, not shown here, is attached to the HVAC infrastructure in the basement of the building.**

ft by 116 ft, or roughly one-third of a floor. This space is representative of a typical IT office environment with semi-enclosed cubicles consisting of office appliances like laptops, desktops, and LCD monitors. Permanent ceiling-mounted fluorescent lighting is the primary light source and is controlled by a small number of light switches. This lab regularly seats approximately 50 students and faculties. A complete inventory of the appliances found in this laboratory is listed in Table 1.

We deployed a total of 38 wireless AC plug-load meters and 6 light sensors as shown in Figure 2. 9 AC meters were deployed at the power strip level and the rest at the single appliance level. Some appliance-level meters belong to sub-trees rooted at power strips that are also metered. These configurations provide us with fine-grained, time-correlated data, including both detailed load profiles of individual appliances and aggregate traces of power strips. By using light sensors to infer whether a set of lights is on or off, we can easily estimate their electricity usage without having to directly measure high-voltage power. This network of meters and light sensors has been transmitting energy and light readings to a server at a rate of one report per minute for the past six months, and has collected over ten million readings. Since this set of empirical measurements is still relatively sparse in comparison to the total number of loads, we present several techniques, and formulate several models, to better



**Figure 3. Wireless AC plug-load meter.**

approximate a detailed coverage of the ideal load tree. We present some details of our AC meter and wireless network used in this study in the remainder of this section, and in more detail in previous work [16].

#### 4.1 Wireless AC Plug-load Meter

To enable high-fidelity continuous measurements of plug-loads at scale, we designed a wireless energy meter capable of measuring real, reactive, and apparent power at a maximum sampling rate of 2.8kHz and load power up to 1800 watts, as shown in Figure 3, and described in more detail in prior work [16]. At the same time, we address physical design questions such as form factor and thermal issues in order to enable rapid deployment in an office environment.

The AC meter API supports operations such as *read\_energy()*, *read\_power()*, and *report(ip\_addr, rate)*. These operations are exported to the rest of the network, and potentially the Internet, using 6LoWPAN [23] header compression.

#### 4.2 Network

A network of meters is essential to obtain time-correlated coverage of energy consumption over large spatial and temporal extents. Traditional energy monitoring solutions use a serial port or other wired backchannel to connect instruments to data loggers, which is not scalable or practical at large scales. Our wireless network allows quick deployment and instrumentation of a large number of AC plug meters by using an ad-hoc network layer which provides IP connectivity to the meters without requiring either wiring installation or support infrastructure, as described in more detail in [16]. The network provides connectivity between the meters and other networks using an IP router.

Figure 2 shows the connectivity graph of 44 wireless sensors over the deployment space. They form a moderately dense network with an average degree of 4. Each sensor node is configured to report energy readings once per minute via UDP to a simple daemon process running on a server. Each UDP packet includes a sequence number, the energy used in the previous minute, and average, minimum, maximum, and last instantaneous power observed during this interval. The server process timestamps the readings and stores them in a database for later processing.

## 5 Improving Coverage

A substantial challenge in constructing a high-fidelity electricity measurement network is that we have neither the ability nor the budget to measure every device. To address this shortcoming, we instead create models of the behavior of each type of appliance by using measured data of similar devices. In this section, we describe strategies that use multi-modal data collected throughout our network to construct accurate appliance electricity consumption models, enabling us to infer consumption of unmetered devices.

A model of appliance behavior is only as good as the data collected to support that model; however, there are often multiple ways to measure the usage of a single appliance. For example, the electrical consumption of a refrigerator can be obtained in a variety of ways – directly measured using a power meter, estimated using a log of door opening events or a time-series of internal light measurements, or inferred through a record of proximity events where people in the vicinity of the refrigerator imply increased consumption, for example. In each of these cases, the sensors are capturing different phenomena that describe the same underlying behavior, namely the electricity consumption of a refrigerator. Thus, to begin our appliance modeling, we examine some fundamental questions concerning sampling: what behavior of the appliance should be measured? How often should we sample to capture the specific phenomena we are interested in observing? In this section, we first explore how various sample window strategies affect the conclusions we reach.

We continue by presenting multiple strategies for constructing appliance models, including using empirical measurements to calculate average energy consumption by minute, hour, and day, accounting for the behavior of individual components at the sub-appliance level (within a machine), and substituting alternate sensors to infer the consumption of electricity of loads that are not easily measured directly. For each of these cases, we show an instance of applying our strategy using data collected by our network, and discuss the applicability of these strategies to other scenarios. However, we emphasize that these strategies themselves are not novel – we simply employ them to study the traditional systems questions of coverage and fidelity in the context of a multi-modal electricity monitoring network.

### 5.1 Additivity

Like all flow graphs, an intrinsic property of energy load trees is additivity - the sum of the power of children nodes equals the power of the parent. For example, Figure 4 shows a branch of the load tree with breaker 23 as the root. The total power flowing out of breaker 23 is the sum of the power drawn by power strips A and B; the power through power strip A is the sum of a laptop, a sub-power-strip and a 24" LCD screen.

Intuitively, this allows us to increase coverage by summing all the children, given that measurements are available for all of them, or increase fidelity by calculating the difference between a measured parent node and measured children nodes. In Figure 4, if we place meter M1, M2, and M3 at power strip A, the laptop, and the sub-power-strip respectively, we can calculate the power of the 24" LCD using



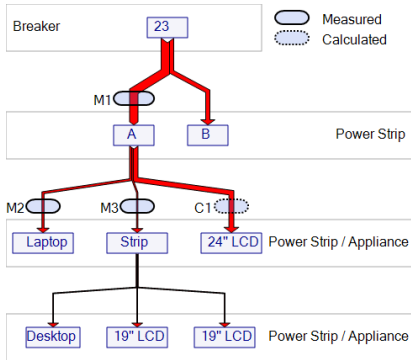
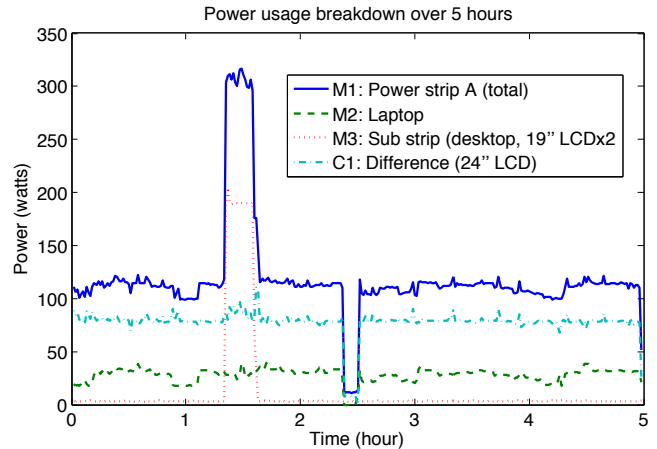

**Figure 4.** The power that flows through power strip A is the sum of the power consumed by the laptop, the 24" LCD, and the sub-power-strip. We can calculate the power at C1 by simply subtracting M2 and M3 from M1.

simple subtraction. In practice, M1, M2, and M3 perform power measurements according to their own clock, and will produce readings that are not synchronized. One solution to address this issue is to perform network synchronization and time-stamp each measurement, at the cost of additional network bandwidth and energy; alternatively measurements can be time-stamped at the collection point, with less accuracy. In either case, power traces from different meters are usually shifted in phase and often differ slightly in periodicity, in addition to holes in the data. As a result, before computing differences or sums, we need to first clean up the data by resampling it, which can be easily done *post hoc*. Figure 5 shows both measured and calculated power of a student's desk appliances for 5 hours. The load tree for this student is shown in Figure 4, rooted at power strip A. We can observe from this figure that the 24" LCD is not connected to the desktop but to the laptop, since its power drops from 80W to 10W when the laptop is disconnected momentarily at 2.5hr.

While applying this technique is straight-forward, it only works when all N-1 nodes are directly measured in a size N parent-children set. However, if the number of metered nodes is less than N-1, in the absence of any other disaggregation techniques, any configuration of metering is equivalent and results in the same degree of visibility.

What is perhaps a more powerful result of additivity is that one can freely combine a subset of children belonging to the same parent into a new subtree in the graph without changing its flows. Physically this corresponds to inserting a power strip to a parent outlet and connecting some subset of devices plugged into the outlet to the new power strip. This allows us to instrument the aggregate power trace of the newly formed subtree rooted at the new power strip. In Figure 4, the desktop and two 19" LCDs can be thought as originally belonging to power strip A (measured by M1); a new power strip is inserted to create the current subtree, measured by M3. This gives us more flexibility in choosing what combination of loads to monitor in aggregate. We can separate devices with similar signatures and group together devices with easily detectable signatures, for optimal disaggregation, as described by [15], [19], and [8].



**Figure 5.** The power profile of a 24" LCD can be calculated by subtracting both the laptop metered at M2 and the sub-power-strip metered at M3 from the power strip A, metered at M1. At 1.5hr, the desktop and two 19" LCDs are turned on, using an additional 200W seen by M3 and M1 for about 20 minutes. At 2.5hr, the laptop was removed from the workspace, reducing M2 to 0W. The 24" LCD drops into standby mode after being disconnected from the laptop, drawing around 10W via subtraction.

## 5.2 Multi-resolution

Certain features of a particular device can only be seen at certain resolutions. Using the power profile of a refrigerator as an example, shown in Figure 6, different resolutions reveal different stories. Figure 6 (B), at a resolution of one sample per minute, clearly shows two intrinsic characteristics or modes of the refrigerator - the compressor kicks in about every 15 minutes while the defrost cycle has a period of around 1 hour. If we zoom in to the turn-on transition and view at a resolution of 4Hz, as shown in Figure 6 (A), we can observe a spike of more than 1000 watts. This observation, which is potentially important for load disaggregation algorithms, would have been lost at the minute resolution. If we step back and view its load profile at an hourly resolution, we start to see human influence in the refrigerator's energy usage. The increase in energy consumption around 1PM and 8PM indicates increased usage during lunch and dinner. In some sense, the refrigerator becomes an instrument for characterizing the daily "power" profile of people.

It is clear that each graph reveals a different story about the refrigerator's power usage by observing it at a particular resolution. Therefore, we need to choose an appropriate resolution, sampling, filtering, and smoothing windows to both preserve the power characteristics of the device, as well as provide clarity to the human who observes and analyzes the data.

## 5.3 Empirical Model

To construct models of devices that are not measured, we average the time-series of devices that are measured. These measured devices are of three varieties: (1) loads measured directly, (2) loads calculated using the additivity method de-

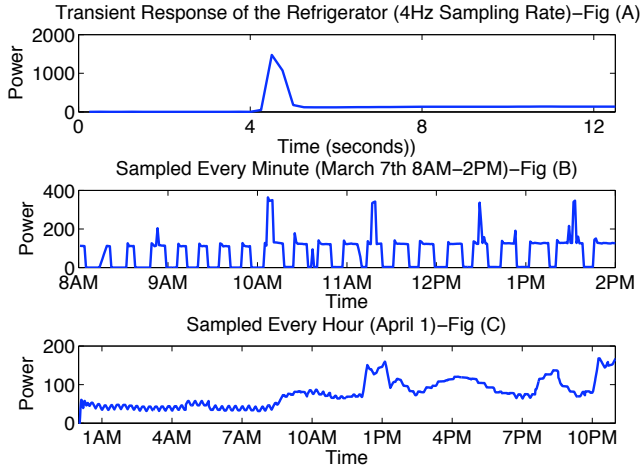

**Figure 6. Sampling rate top to bottom: 4Hz, minute sampling, hourly sampling. (A) reveals the turn-on transient; (B) reveals the compressor and defrost modes of the refrigerator; and (C) reveals the human influence.**

scribed in Section 5.1, and (3) loads calculated using measured power strips. We describe each of these in turn.

The first variety is the simplest - measurements are provided directly from AC meters connected to similar devices throughout the network. Since the electricity data are recorded every minute, that is the minimum granularity of our power models, though in practice we use hourly consumption in our calculations.

Next we find each device whose power is not directly measured by an AC meter, but can be calculated because all of the other devices in its subtree are measured directly. We call this a *constrained subtree*. By leveraging the hierarchical nature of load trees, we can subtract to find the consumption of this type of device. Together with the directly measured devices of the same type, these measurements combine to form the baseline *core* power model for each appliance type.

The final step in creating individual device power models, called the *proportional scaling step*, is to find those devices that have a parent appliance measured but are not part of a constrained subtree (e.g. multiple unmeasured appliances connected to a power strip instrumented with an AC meter). In this type of case, we begin with the core power model for each appliance. We then proportionally scale the estimate of the unmeasured devices by using the available aggregate measurement from the parent device – that is, we scaled what we would expect from the composition of the unmeasured devices by what we have actually measured at the power strip. Figure 7 shows a core model and scaled model for four specific appliances in our deployment. If aggregate measurements are unavailable for a device, we use only the core power model for that appliance.

After this process, we arrive at models for each appliance in the system that incorporate as much relevant empirical data as possible – devices not measured are a composition of measured devices of similar type, while devices that are measured indirectly additionally reflect those measurements.

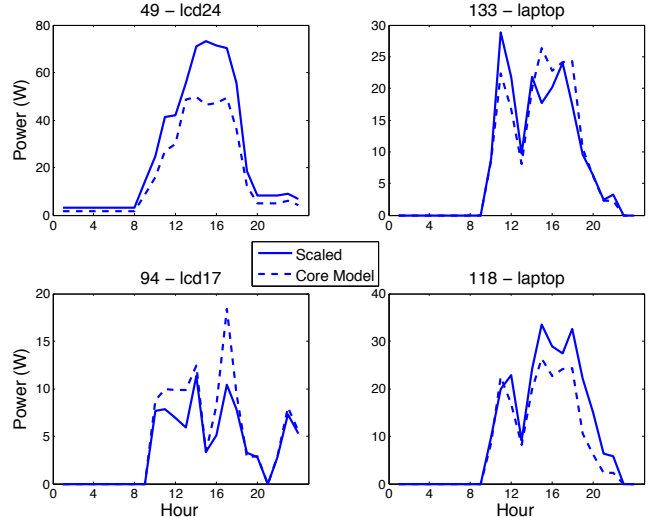

**Figure 7. Result of calculating an improved empirical model using proportional scaling from a measured aggregate. By using upstream power measurements in addition to generic models of appliance behavior by type (“core power models”), models for specific appliances can be augmented to incorporate device-specific measurements. Here we look at a 24” LCD, a 17” LCD, and two laptops.**

We use these individual appliance models as the basis for the office-wide composition models throughout this paper.

#### 5.4 Appliance Signature Analysis

Modern electronic devices are a composition of many sub-components. These multi-component, multi-state devices have distinguished power traces per state that uniquely identifies them. This leads to the conjecture that perhaps the natural level of disaggregating a load tree is not at the appliance level but at the sub-components of the appliance. Figure 8 (A) shows the power trace of the laptop. We can pull out two components – the charging curve of its battery, as modeled in Figure 8 (B), and the rest of the laptop consisting primarily of the CPU, LCD, and fans, as shown in Figure 8 (C). In this case, we model the laptop charging curve as an exponential decay with formula shown in Equation 1. This may aid in disaggregating the laptop power because now we have a generic model for the sub-components of this type of laptop.

$$26.33 \times e^{-3.366 \times 10^{-2}(x+4)} + 12.33e^{-7.217 \times 10^{-4}(x+4)} - 10.48 \quad (1)$$

Additionally, devices that exhibit daily patterns in their power traces allow for creation of accurate models of daily consumption from historical data, precluding the need to meter such devices. In Figure 9, we see the power consumption of the Water Dispenser over the same day of the week for three weeks, excluding the week of spring vacation. Though no clear pattern exists, a rough average can be extracted from Figure 9 (B), which shows the daily human influence on the device’s power trace. However, looking at the cumulative

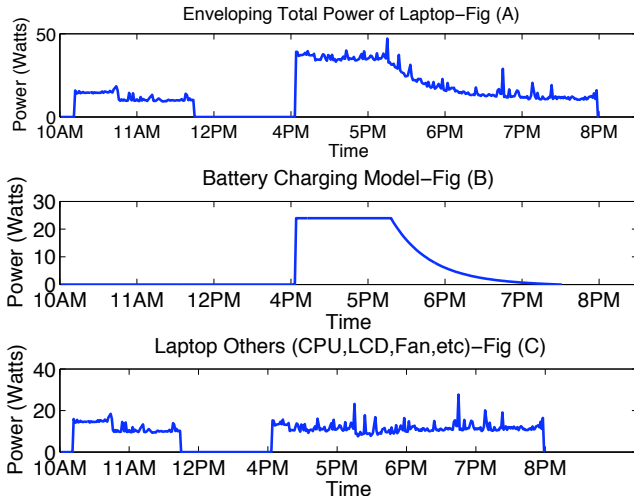

**Figure 8. Laptop energy consumption disaggregation at the sub-component level.**

graph of Figure 9 (C), a clear correlation in the cumulative power consumption of each Wednesday emerges.

The fundamental fact is that the power trace of an appliance is the superposition of power traces of multiple sub-components within that appliance. In the case of a laptop, the power trace of the charge and discharge state of its battery, the CPU, and the LCD can be modeled separately; therefore, the most basic unit of disaggregation may not be the appliance, but actually the functional units within it. Moreover, the process of inference and disaggregation involves identifying not only the patterns within the device, but also the effects of human interaction with the device.

## 5.5 Multi-modal Sensing

One challenge often encountered when trying to instrument a building is that certain consumers of energy are either hard to measure or inaccessible. For example, HVAC electrical energy is converted to other forms of energy in a central location, which is secured and inaccessible. Even if one is to obtain permission to enter the premises, special sensors such as CT clamps are needed to monitor consumption. However, there are multiple ways to obtain equivalent energy measurement without directly measuring consumption.

HVAC systems such as chillers and pumps usually contain relatively high horsepower motors. A close inspection of our building-wide HVAC control room reveals that these systems produce very noticeable vibrations. To demonstrate this, an Epic-based node [12] with both a three-axis accelerometer and a vibration sensor was used to measure the duty-cycling schedule of a motor that drives an air conditioning unit. Multiplying this duty cycle by the ON power produces a real-time power profile. Figure 10 (A) shows a trace of one axis of the accelerometer over an hour, and Figure 10 (B) shows a trace of a vibration sensor over the same hour. For the particular vibration sensor used, the number of threshold crossings at each motor event varies, but the sensor identifies the beginning of motor events well. Either type of sensor produces a proxy measurement for calculating the electrical energy used

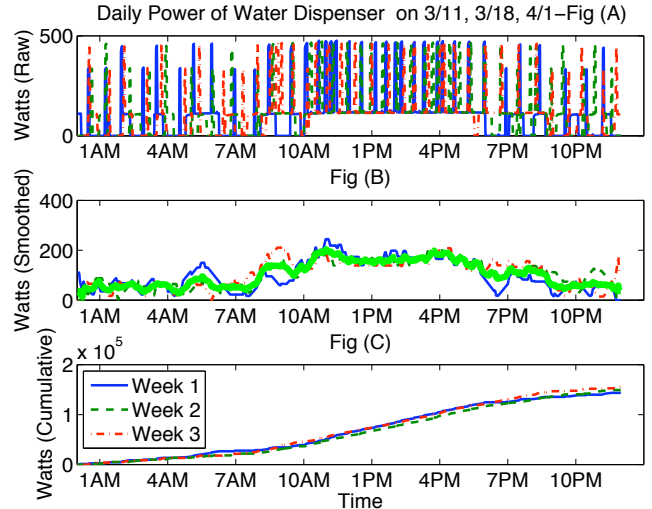

**Figure 9. Water dispenser daily energy consumption over the same day of the week for three weeks. Notice the general trend in power consumption in (B) as well as in (C).**

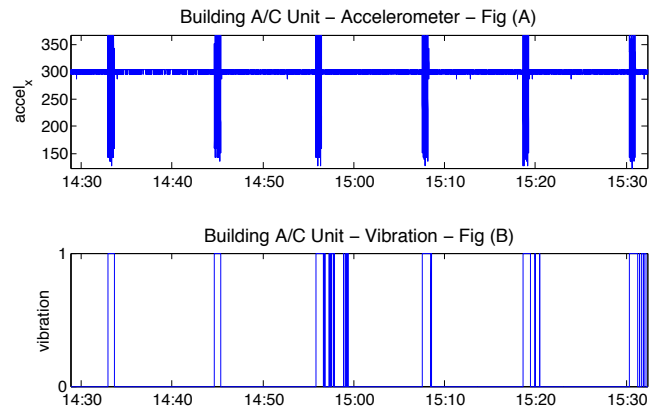
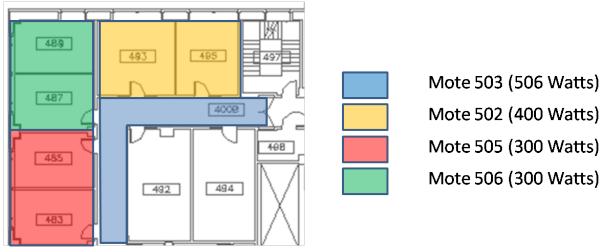

**Figure 10. Figure (A) shows the output of one axis of an accelerometer attached to a large motor driving air conditioning equipment over an hour. Figure (B) shows the output of a simple vibration sensor attached to the same motor over the same hour. Each sensor indicates when the motor is operating and allows for real-time estimation of HVAC energy consumption.**

by a large motor that is otherwise cumbersome to measure.

Additionally, in most cases, sensors appropriate for a particular form of energy can be used to measure it in its natural unit then convert back to electrical energy using the transfer function along the path of the conversion process. For example, temperature sensors could be used to detect heat flow or AC usage, and flow sensors could be used to detect ventilation usage.

Furthermore, un-conventional sensors can be used to infer usage or help in improving the accuracy of existing electrical sensors. For example, proximity sensors carried by individuals can be used to determine the human component to the power profile of refrigerators, or they can be used to allow real-time energy accounting of shared resources such



**Figure 11. Only 4 light sensors are needed to cover 26 light bulbs since they are controlled together by 4 sets of switches and motion sensors.**

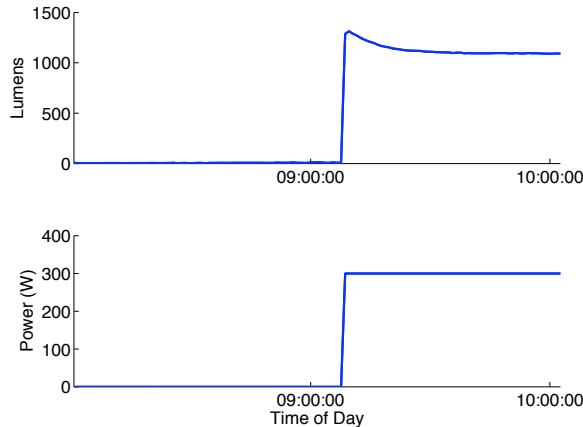

**Figure 12. Light sensor readings can be easily converted to power using thresholding.**

as refrigerators or water heaters, as described in more detail below.

Another shared resource to account for is the energy consumption of overhead lighting. However, to measure it directly, we would need more than ten high-voltage sensors such as CT sensors installed in the electrical panel – this is both cumbersome and costly. Instead, recognizing the fact that all 26 lights fall into 4 light “zones”, controllable only in aggregate, we can simply instrument one light bulb for each of the 4 light zones, as shown in Figure 11. We deploy six Telos motes [25] equipped with light sensors and programmed with the same sampling schedule and networking stack as the plug-load meters.

The top graph in Figure 12 shows the raw PAR (photosynthetically active radiation) readings while the bottom graph shows the projected power reading using a simple binary filter with a constant multiplier. As we can see, PAR readings change from near zero to roughly 1085 lumens at around 9AM, indicating that the light has been turned on. The ON/OFF transition is obvious, and can be converted to a 1 or 0 using a simple threshold. To find the ON power, we simply counted the types of light bulbs and summed their rated power.

## 6 Decomposition

Disaggregating the load tree down to its leaves - the individual loads - gives us the basic building block from which we can recombine according to other grouping criteria. De-

composition allows one to better understand the data, identify areas for improvement, and create more actionable forms of visualization.

In this section, we present three ways to recombine our computer science building load tree - by function, by space, and by individual. Functional decomposition recomposes the load tree by function. For example, in our initial load tree in Figure 1, we can group all three LCDs into one functional group - LCD, and the laptop with other students’ laptops into another group - laptop, and so forth. This is arguably the most natural form of recomposing a load tree - a direct regrouping of leaves according to their function. Spatial decomposition recomposes devices based on where they are. This allows us to answer questions such as “Which room uses the most energy?” or “What is the energy consumption of the machine room?” Unlike the functional decomposition, the unit of recombination is often higher in the load tree, such as power strips or even circuit breakers. However, for some devices that are shared in space such as lights, one might need to subdivide it based on what proportion of it is illuminating a unit of space. Individual decomposition recomposes the loads by personal usage. For most appliances in an office, it is a simple one-to-one correspondence, but for some shared appliances such as refrigerators and lights, they should be attributed proportionally to different individuals over time based on some definition of usage.

To enable functional, spatial, and individual decompositions, we perform a detailed survey of a portion of the 4th floor, as shown in Figure 11. We associate meta-data with each device in a database, such as its type of appliance, where it is, and to whom it belongs. The number of loads and sensors are shown in Table 2. We apply techniques described in Sections 5 to disaggregate the load tree into 96 appliances, each with average hourly power consumptions over a day, some directly measured and some inferred.

Category	Counts
Rooms and cubicles	6
Students	28
Appliances	96
Lights	26
AC Meter	19
Light sensors	4

**Table 2. Survey of densely instrumented region, depicted in Figure 11.**

### 6.1 Functional Decomposition

Functional decomposition groups together loads that are of similar type. This type of aggregation is useful in studying characteristics for a particular load class, finding trends, and making comparisons between load classes. This view also helps in validating the effects of a targeted energy reduction effort by looking at the aggregate power of a particular load class over time.

For example, Figure 13 shows a small portion of the load tree that includes four different functions or load classes - laptop, desktop, LCD, and light. Using techniques described in the previous sections, we disaggregate the load tree into



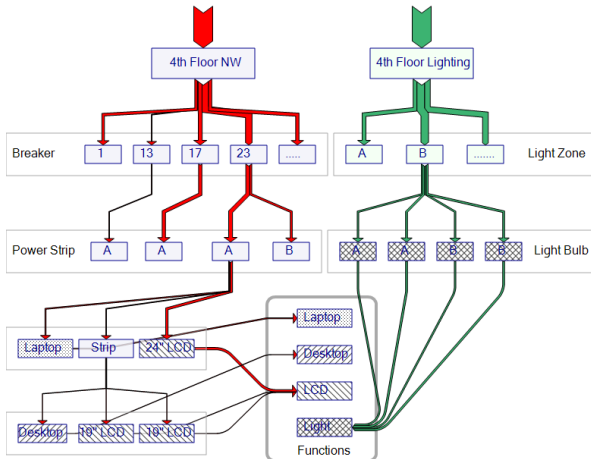

**Figure 13.** A portion of the load tree is decomposed into individual appliances, then re-aggregated into four functional classes - laptop, desktop, LCD, and light.

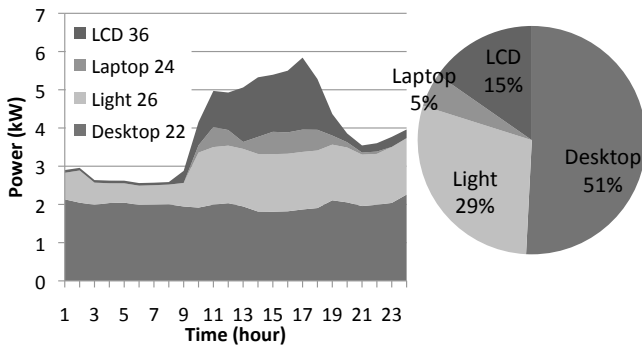

**Figure 14.** Stacked graph of aggregate power consumption grouped by functional class over a day.

individual loads (leaves of the tree), albeit with varying degrees of accuracy. With meta-data associated with each load, in this case the function, we re-aggregate by simply summing across functions. Other statistics over these functional groups such as average and variance are often useful for understanding characteristics of loads as well.

By grouping 96 appliances and 26 lights into four functional classes, we can observe their respective contribution to the total load and their tread over the course of a day, as shown in Figure 14. We see that desktops are by far the largest energy consumer, accounting for more than half of the total energy. Furthermore, they stay on regardless of the time of day. Using functional decomposition, we identify that students and professors fail to turn off desktops after leaving the lab, wasting approximately 30kWh of energy every day. In comparison, laptops are much more efficient, using only 5% of total energy. Lighting power consumption is also very revealing. During the day, it remains at peak usage, as one might expect since most office buildings do not adjust lighting level based on ambient light. However, from this figure, we see that lights remain at maximum power from hour 20 until midnight (and likely later if we choose a longer view) even when there is very little computer usage,

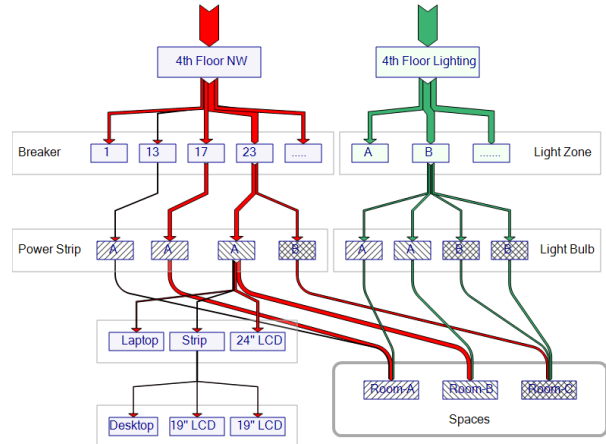

**Figure 15.** Spatial decomposition of the load tree. Three rooms (Room-A, Room-B, and Room-C) contain several plug loads (laptop, desktop, LCD screens) and light fixtures. Directly measuring the energy used by a particular space may not be possible if power arrives via multiple load trees, like wall outlets and built-in lighting.

as evidenced by the minimal LCD power. This shows us that either the time out for the light auto-shutoff (triggered by the motion sensors) is longer than the periodicity of human movement at night, or that one or two students are keeping all the lights on. The power consumption of LCDs seems to track laptops fairly accurately, showing that in this laboratory, most students and professors use laptops as the primary computing platform, as opposed to desktops.

## 6.2 Spatial Decomposition

Disaggregating the load tree provides visibility into the energy consumption of individual loads, but it does not provide visibility into how energy is consumed over space. For example, how much energy does the fourth floor use per day? What is the average power drawn by each office? What does the instantaneous power draw of a laboratory “look” like? Answering such *spatial decomposition* questions requires energy consumption to be projected onto space, potentially from multiple load trees, and reaggreated along spatial boundaries. Figure 15 illustrates this problem for a typical environment and the remainder of this section presents our initial efforts to project energy consumption over space.

For each disaggregated load in our database, we maintain coordinate fields that include a load’s approximate x, y, and z coordinates within the building. We also maintain a database of logical and physical spaces like offices, conference rooms, hallways, floors, or even the entire building. Each one of these spaces is defined by a bounding box consisting of six planes. For simplicity, we assume a rectangular building with bounding planes orthogonal to the building walls, but the basic idea can be generalized to arbitrary-shaped bounding boxes. Computing a spatial decomposition is then a simple matter of filtering loads by their coordinates.

Although coordinates provide point locations of energy consumption, in some cases the utility of an electrical load actually spans a wider physical area. Lighting, for exam-

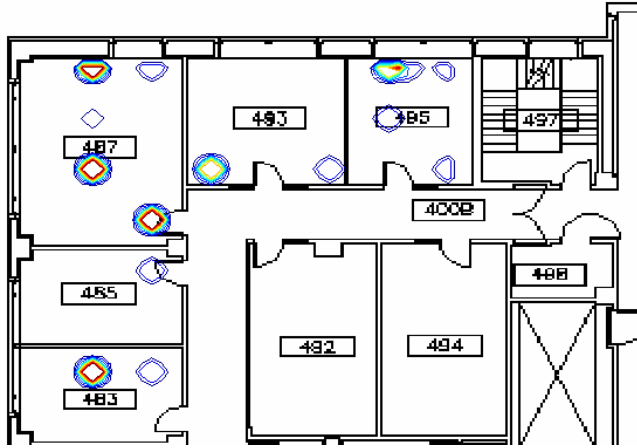

Figure 16. The spatial energy consumption across several offices in an office building. The empirically measured average power draw of several loads is averaged over space using a square smoothing kernel with rounded corners. This figure highlights that the occupants in room 487 have a higher average power demand than those in neighboring offices.

ple, can illuminate a single desk or an entire room. Heat can propagate across a room from a single space heater. And a projector, radio, or TV can inform or entertain all the occupants in the room. In such cases, it can be useful to distribute the energy used by a load over space using a smoothing kernel, especially if the consumption data are to be used for visualization purposes. Visualizing spatial energy consumption, however, presents an additional wrinkle to the problem: energy consumption in one space is often unrelated to consumption in an adjacent space. For example, a halogen lamp placed next to a wall usually illuminates only the room in which it is located. While it may be useful to smooth or spread such point loads over space, indiscriminately doing so leads to unexpected and perhaps inaccurate results.

We currently visualize spatial energy consumption as follows. We begin with a blueprint-style floorplan of the space. We then create a pair of two-dimensional matrices whose ratio of rows to columns match the aspect ratio of the physical space. The actual number of rows and columns depends on the desired spatial granularity (in our current design, each square foot of space is mapped to one element in the matrix). For each load in this space, we first add its consumption to the corresponding element in the first matrix, then run a load-specific smoothing kernel over the matrix, then zero all elements that fall outside of the load's nearest enclosing space (typically the surrounding walls), and finally add the resulting values to the second matrix. This process is repeated for each load in the space to be visualized. Once all loads have been smoothed, truncated, and projected onto the second matrix, we generate a contour plot over the second matrix and project a transparent copy of the contour onto the floorplan. Figure 16 shows the output of this process.

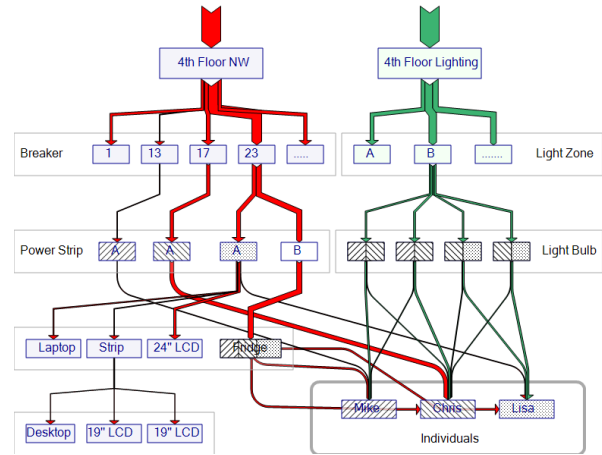

Figure 17. Individual decomposition of the load tree. Three building occupants use a mix of electrical loads. Some loads, e.g. laptops or desktops, are dedicated to one user while other loads, e.g. lights or a refrigerator are shared by some subset of the occupants. Directly measuring an occupant's fractional usage may not be possible so approximation techniques are needed.

### 6.3 Individual Decomposition

A common question among building occupants is the deceptively simple, “What is *my* energy consumption?” None of the decomposition approaches already described answer this question. Functional decomposition can provide the energy usage of each load, but a single load may be shared by multiple people, as in the case of the lights or a refrigerator. Spatial decomposition can provide visibility into the energy consumed over space, and identify power hotspots in a building, but it does not tie this usage to specific occupants. In this section, we present our preliminary approach to addressing the *individual decomposition* question, illustrated in Figure 17, and some thoughts on extending this approach.

To estimate the energy consumed directly by an individual, each dedicated load is tagged with its owner's information. Computing the *direct* energy footprint becomes a matter of aggregating the consumption across all loads “owned” by a single user. Computing the fractional contribution due to shared load is a little a bit more challenging. For each user, we identify the nearest enclosing space (e.g. office or wing), aggregate the energy usage of all shared loads in the space (e.g. lights, refrigerator), and then divide by the number of occupants whose “home” coordinates fall within that enclosing space. The resulting figure provides a *per capita* energy usage of the shared resources.

Figure 18 illustrates the individual decomposition gathered from our empirical data. The data reveal a number of interesting observations. Most notably, individual consumptions have a wide distribution and the “typical” consumer is the one who does not appear to actually spend time near his or her devices. Of the daily average energy usage of 89 kWh, 63 kWh is due to dedicated resources and 29 kWh is due to shared resources. For just over half of the occupants, the dedicated component of consumption dominates the shared

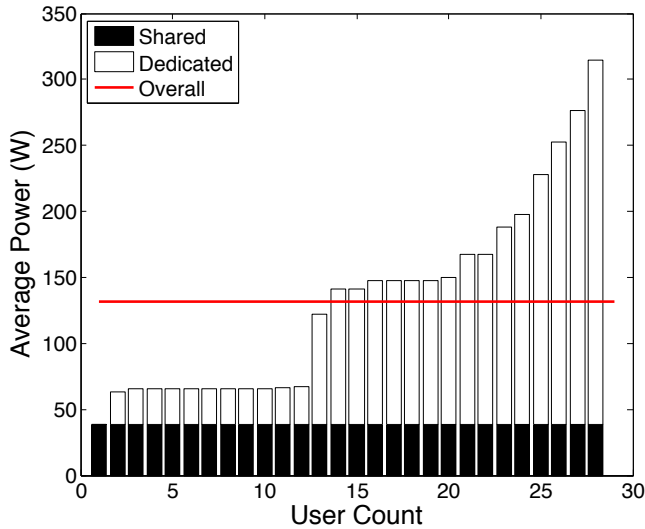

**Figure 18.** The distribution of per-occupant average power across a group of nearby occupants. The overall average draw (across all occupants in the monitored area) is 132 W. Each bar includes the fractional contribution from the shared lights and refrigerator (38.5 W), as well as the dedicated contribution from each user’s personal loads like laptops, desktop, and monitors.

component. However, for just under half the occupants, the shared contribution is slightly greater than the dedicated one (which is due almost exclusively to idle LCD panels). This suggests that some users who do not use their LCD panels regularly should turn them off.

While Figure 18 provides some insight into individual decompositions, and provides some guidance into how group usage could be reduced, it does not easily distinguish useful and wasted energy. For example, if a user is near his or her computer and actively using the LCD screen, we might call that energy consumption useful. In contrast, an LCD screen that displays the screen manufacturer’s logo as a screen saver all night while the user is asleep might be called wasted energy. Currently, we do not distinguish between these two cases. One possibility for this additional level of decomposition that we are currently exploring is to have users carry a wireless keyfob or amulet that listens for radio transmissions and periodically reports the list of recently heard nodes to a server. Using this crude form of localization, we may then be able to further decompose individual consumption into times when a load spends energy in the presence of its owner and times when it spends energy in the absence of its owner. Additionally, by attributing energy consumption to a mobile user, we can readily calculate how an individual’s energy footprint spreads across time and space.

#### 6.4 Electrical Decomposition

Beyond the scope of individual consumers of electricity, another critically important stakeholder in the electricity tree of an office building is the facility personnel. These people are principally concerned with aggregate electricity measurements, and often only monitor electricity at a whole-building scale. Though the functional decomposition in Sec-

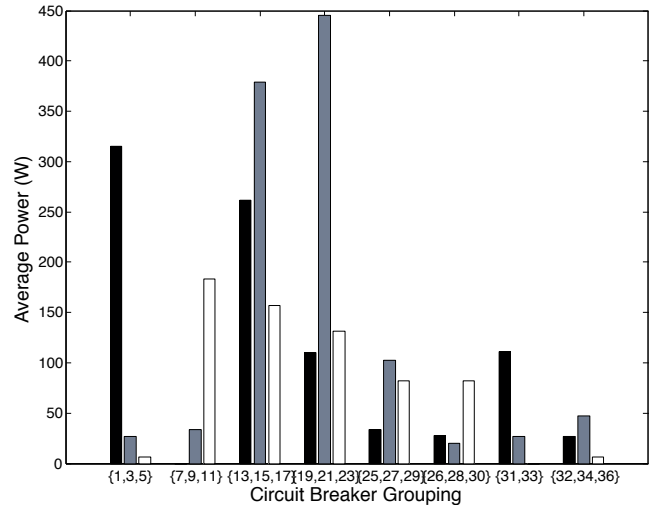

**Figure 19.** Per-circuit loads in our office deployment. Loads can be migrated within each grouping simply by moving to a different socket on the same outlet. This data could guide a building manager to improve load balancing among circuits.

tion 6.1 provides many powerful analytical methods to building personnel, this section aims to examine one more: a decomposition based on electrical system structure. This is especially relevant to facility personnel because they are often the sole stakeholder aware of the electrical layout of a building: the distribution, breakers, and branches of the load tree. To display the benefit of having measurements categorized by electrical structure, we examine a particular anecdote that arises as an artifact of our office’s electrical system but may provide guidance for future electricity decomposition exercises.

In the office setting under study, electrical sockets are made available to people through a series of *floorboxes*, where a floorbox consists of connections to all the wired services of the building: telephone lines, Ethernet ports, and electricity. In each floorbox, there are two sets of two outlets each, with each set of outlets in a particular floorbox on a different breaker circuit. However, the pair of breaker circuits in a floorbox is unique – that is, no other floorbox will have access to the same two circuits. Additionally, to further distribute load in the office, an individual circuit is always shared between two floorboxes, resulting in a situation of *circuit triples*, whereby each member of the triple shares exactly one floorbox with each other member of the triple. This design is intended as a strategy for distributing load across the circuits; Figure 19 shows both the electrical load of each circuit as well as the distribution of loads across a circuit triple. In cases where the loads on a circuit triple are extremely disparate (e.g. circuits 1, 3, and 5), distributing load can be achieved by simply relocating plug-loads from one outlet in a floorbox to another, protecting the electrical system from overload.

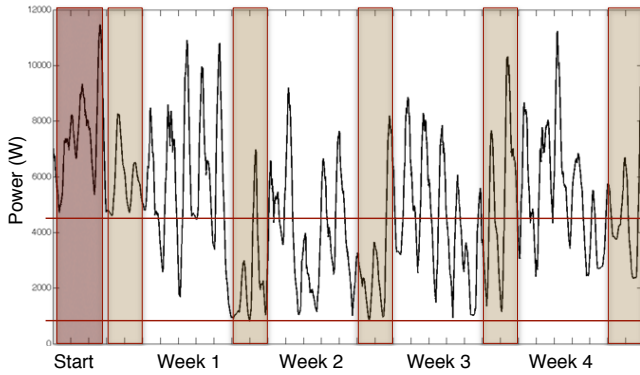

**Figure 20. Aggregate trace of measured LCDs in the laboratory over a four-week period. The white rectangles represent the work week, shaded vertical strips highlight the weekends, and the solid horizontal line represents the average consumption over the entire duration.**

## 7 Improvements

By far, the most beneficial result in building a dense energy measurement network is opening the door to a potential wealth of electricity savings. In this section, we relate two specific anecdotes that resulted in reduced electricity consumption, the first of which resulted in up to a 32% reduction in LCD electricity consumption, and the second of which slashed the sleep power of a desktop computer by a factor of 50.

Figure 20 provides an aggregate consumption of all of the LCD monitors measured in the laboratory over the course of four weeks. Table 3 provides the weekday average for each five-day period, represented by a white rectangle on the graph. At the beginning of this timeframe, the authors made a presentation to the laboratory that enumerated the wastage of LCD monitors when unplugged from laptops but not turned off. This, along with generally spreading the word about the electricity measurement network, led to a significant initial reduction in LCD energy consumption - nearly a third from week 1 to week 2. However, as the effect of this impulse diffused, so did the reduction in electricity consumption, nearly returning to week 1 levels by week 4. Without drawing any concrete conclusions from this experiment, it appears that a single notice, though initially powerful, may taper off in effect over time without reinforcement.

We note that the aggregated measurements may include loads that are themselves aggregated, such as power strips that contain both an LCD and a desktop. Though this places the meaning of the absolute values from the figure in jeopardy, we feel that the relative pattern is not obfuscated.

The second anecdote deals with our experience reducing

Week	1	2	3	4
Average Power (kW)	5.92	4.03	4.53	5.70
Change (%)	N/A	-31.9%	+12.5%	+25.8%

**Table 3. Work-week average aggregate power for measured LCDs, along with week-by-week percentage changes.**

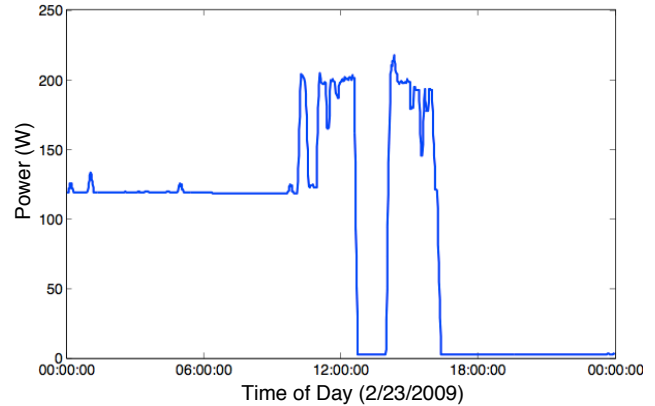

**Figure 21. This is a trace of a student's desktop machine running Windows XP before and after installing power management software. The machine was reconfigured on this day to drop into full sleep mode after 15 minutes of idleness, reducing the idle power from 119.0 Watts to 2.4 Watts.**

the idle energy consumption of desktops running Windows as their operating system. Our analysis begins with observing that the idle average wattage of a typical Windows machine in the laboratory is roughly 119.0 Watts. As this is excessive for a computer doing no useful work, we sought out various energy management solutions, including both third-party packages as well as Windows' own energy management suite. We decided on a third-party product named Auto Shutdown Manager [13], which provides the ability to set both thresholds and more complex rules for shutting down and waking up the PC and its components.

In our experience, the software detected keep-alive packet traffic that was preventing any of the existing energy-saving algorithms from taking hold by triggering the Wake-on-LAN function of the machine's network card. By blocking these requests and experimenting with a variety of thresholding schemes (i.e. go to sleep when there is no mouse or keyboard activity for 10 minutes and CPU utilization remains less than 40% for the entire duration), we were able to get the machine to regularly go to sleep when not in use. The effect of this change is shown in Figure 21, a time-series of power readings during the day when the auto shutdown software was enabled. The average power usage after the change is only 2% of the usage prior to the change (2.4 W versus 119.0 W). No doubt this change makes a significant difference, but it does come with the tradeoff of increased wake-up times - machines take about 10 seconds to become operational when triggered after sleeping.

To quantify the potential total energy reduction if all of the desktop PCs in the laboratory were running Windows and experienced similar proportional reductions in their idle power usage, we applied the same rules as on the initial machine to traces of power consumption from each of the other measured desktops. We continued this analysis by recalculating the models for each desktop in the lab, and present the results in Figure 22. This graph shows a 15% reduction in the peak envelope and a 30% reduction in the baseline



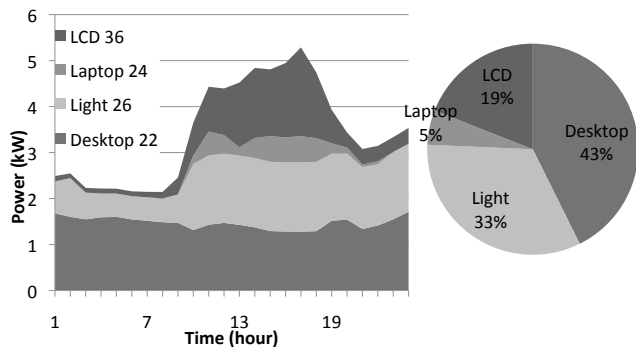

**Figure 22. Estimated functional decomposition of the laboratory energy consumption if all of the desktops incorporated energy management software.**

desktop energy consumption. Going forward, we intend to deploy this software more widely, both in the lab as well as externally.

## 8 Conclusions

Wireless sensor networks have been widely deployed for monitoring space (e.g., microclimate and habitat monitoring) and monitoring things (e.g., condition-based maintenance, asset tracking, and animal behavior). Some of the most important applications of this technology going forward will be in reducing energy consumption and environmental impact. In this paper we have described our experience in building and using a network for high-fidelity energy usage monitoring. This turns out to be a network for monitoring the interactions of space and things, and many classic sensor network issues appear within it in a new form.

The fundamental structure of residential and commercial electrical power flow is the load tree. It branches through several levels (transformers, bus bars, panels, breakers, power strips, receptacles) to individual appliances and within those appliances to various subsystems. The coverage problem is recast in terms of this load tree, rather than as overlapping regions of space. Instruments at higher levels of the tree provide broader coverage, but in aggregate form. Placing instruments at lower levels improves fidelity. As it is a network of instruments, measurements from distinct points can be combined to resolve additional specific loads. Sampling the population of things of interest can be used to extrapolate to the larger group. The combined impact of seemingly insignificant features, such as the LCD screen turning on when unplugged to warn the now absent user, can be observed network-wide.

Intelligence at the sensor, in-network processing, and aggregate processing all appear in this network in interesting forms. For example, sampling rate is not just a matter of signal bandwidth. Collecting and processing time-series provides a means of feature extraction which can be used to further disaggregate loads. Combining this with multiple measurements provides means of distinguishing loads with similar, overlapping signatures. Viewing this stream at multiple levels of temporal resolution allows the coarse effects of usage to be separated from the intrinsic behavior of the de-

vice in operation. Or, in conjunction with model building, it may be used to elucidate the internal operational states of the device. Multimodal sensing is utilized to observe activities and infer energy consumption where it is costly or difficult to measure the power usage directly.

While the load tree is the fundamental means of power delivery and consumption, understanding how to reduce energy consumption often involves recomposing the usage in terms of where, why, and by who the energy is used. By associating metadata about the source of all the measurement data and matching it with metadata describing the environment in which it occurs, we are able to construct virtual load trees that project directly onto a functional, spatial, or individual perspective. Ultimately, this ability to measure and model will hopefully lead to broad means of mitigation.

## 9 Acknowledgments

This work is supported in part by the National Science Foundation under grants #CNS-0932209 (“CPS-LoCal”), #CNS-0435454 (“NeTS-NR”) and #CNS-0454432 (“CRI”), an NSF Graduate Fellowship, a Microsoft Graduate Fellowship, a National Defense Science and Engineering Graduate Fellowship, and CITRIS.

## 10 References

- [1] Arch Rock. <http://www.archrock.com/>.
- [2] Google PowerMeter. <http://www.google.org/powermeter/>.
- [3] Green Box. <http://www.getgreenbox.com/>.
- [4] Green Hub. <http://www.energyhub.net/>.
- [5] Microsoft Hohm. <http://www.microsoft-hohm.com/>.
- [6] Sentilla. <http://www.sentilla.com/>.
- [7] Tendril. <http://www.tendrilinc.com/>.
- [8] M. Baranski and J. Voss. Genetic algorithm for pattern detection in nialm systems. *In Systems, Man and Cybernetics*, 2004.
- [9] C. Beckmann, S. Consolvo, and A. Lamarca. Some assembly required: Supporting end-user installation in domestic ubiquitous computing environments. pages 107–124. 2004.
- [10] M. Chetty, D. Tran, and R. E. Grinter. Getting to green: understanding resource consumption in the home. *In UbiComp '08: Proceedings of the 10th international conference on Ubiquitous computing*, pages 242–251, New York, NY, USA, 2008. ACM.
- [11] J. Dobson and J. Griffin. Conservation effect of immediate electricity cost. feedback on residential consumption behavior. *Proceedings of the 7th ACEEE Summer Study on Energy Efficiency in Buildings*, 1992.
- [12] P. Dutta, J. Taneja, J. Jeong, X. Jiang, and D. Culler. A building block approach to sensornet systems. *In Conference on Embedded Networked Sensor Systems (SenSys '08)*, 2008.

- [13] EnviProt. Auto Shutdown Manager, 2009. <http://www.enviprot.com/>.
- [14] L. Farinaccio and R. Zmeureanu. Using a pattern recognition approach to disaggregate the total electricity consumption in a house into the major end-uses. *Energy and Buildings*, 30(3), p.245-259, 1999.
- [15] G. Hart. Nonintrusive appliance load monitoring. *Proceedings of the IEEE*, 1992.
- [16] X. Jiang, S. Dawson-Haggerty, P. Dutta, and D. Culler. Design and implementation of a high-fidelity ac metering network. In *The 8th ACM/IEEE International Conference on Information Processing in Sensor Networks (IPSN09) Track on Sensor Platforms, Tools, and Design Methods (SPOTS 09)*, 2009.
- [17] Y. Kim, Z. M. Charbiwala, A. Singhanian, T. Schmid, and M. B. Srivastava. Spotlight: Personal natural resource consumption profiler. *HotEmNets 2008*, 2008.
- [18] Y. Kim, T. Schmid, Z. M. Charbiwala, and M. B. Srivastava. Viridiscopes: Design and implementation of a fine grained power monitoring system for homes. *11th international conference on Ubiquitous Computing (UbiComp 2009)*, 2009.
- [19] C. Laughman, K. Lee, R. Cox, S. Shaw, S. Leeb, L. Norford, and P. Armstrong. Power signature analysis. *IEEE Power & Energy Magazine*, 2003.
- [20] K. D. Lee. Electric load information system based on non-intrusive power monitoring. *PhD Thesis, MIT*, 2003.
- [21] S. B. Leeb, S. R. Shaw, and J. R. K. Jr. Transient event detection in spectral envelope estimates for nonintrusive load monitoring. *IEEE Trans. on Power Delivery*, 10(3):12001210, 1995.
- [22] J. Lifton, M. Feldmeier, Y. Ono, C. Lewis, and J. A. Paradiso. A platform for ubiquitous sensor deployment in occupational and domestic environments. *IPSN '07: Proceedings of the 6th international conference on Information processing in sensor networks*, 2007.
- [23] G. Montenegro, N. Kushalnagar, J. Hui, and D. Culler. Transmission of ipv6 packets over ieee 802.15.4 networks. 2007.
- [24] S. N. Patel, T. Robertson, J. A. Kientz, M. S. Reynolds, and G. D. Abowd. At the flick of a switch: Detecting and classifying unique electrical events on the residential power line. *9th international conference on Ubiquitous Computing (UbiComp 2007)*, 2007.
- [25] J. Polastre, R. Szewczyk, and D. Culler. Telos: Enabling ultra-low power wireless research. *IEEE SPOTS*, 2005.
- [26] A. Prudenzi. A neuron nets based procedure for identifying domestic appliances pattern-of-use from energy recordings at meter panel. In *Power Engineering Society Winter Meeting*, 2002.
- [27] P. Stern. What psychology knows about energy conservation. *American Psychologist*, 1992.
- [28] U.S. DOE. Buildings Energy Data Book, 2008. <http://buildingsdatabook.eere.energy.gov/>.
- [29] U.S. DOE Energy Information Administration. Commercial buildings energy consumption survey, 2003. <http://www.eia.doe.gov/emeu/cbecs/>.