

# f4: Facebook’s Warm BLOB Storage System

Subramanian Muralidhar\*, Wyatt Lloyd†\*, Sabyasachi Roy\*, Cory Hill\*, Ernest Lin\*, Weiwen Liu\*, Satadru Pan\*, Shiva Shankar\*, Viswanath Sivakumar\*, Linpeng Tang‡\*, Sanjeev Kumar\*

\*Facebook Inc., †University of Southern California, ‡Princeton University

## Abstract

Facebook’s corpus of photos, videos, and other Binary Large OBjects (BLOBs) that need to be reliably stored and quickly accessible is massive and continues to grow. As the footprint of BLOBs increases, storing them in our traditional storage system, Haystack, is becoming increasingly inefficient. To increase our storage efficiency, measured in the effective-replication-factor of BLOBs, we examine the underlying access patterns of BLOBs and identify temperature zones that include hot BLOBs that are accessed frequently and warm BLOBs that are accessed far less often. Our overall BLOB storage system is designed to isolate warm BLOBs and enable us to use a specialized warm BLOB storage system, f4. f4 is a new system that lowers the effective-replication-factor of warm BLOBs while remaining fault tolerant and able to support the lower throughput demands.

f4 currently stores over 65PBs of logical BLOBs and reduces their effective-replication-factor from 3.6 to either 2.8 or 2.1. f4 provides low latency; is resilient to disk, host, rack, and datacenter failures; and provides sufficient throughput for warm BLOBs.

## 1. Introduction

As Facebook has grown, and the amount of data shared per user has grown, storing data efficiently has become increasingly important. An important class of data that Facebook stores is Binary Large OBjects (BLOBs), which are immutable binary data. BLOBs are created once, read many times, never modified, and sometimes deleted. BLOB types at Facebook include photos, videos, documents, traces, heap dumps, and source code. The storage footprint of BLOBs is large. As of February 2014, Facebook stored over 400 billion photos.

Haystack [5], Facebook’s original BLOB storage system, has been in production for over seven years and is designed for IO-bound workloads. It reduces the number of disk seeks to read a BLOB to almost always one and triple replicates data for fault tolerance and to support a high request rate. However, as Facebook has grown and evolved, the BLOB storage workload has changed. The types of BLOBs stored have increased. The diversity in size and create, read, and delete rates has increased. And, most importantly, there is now a large and increasing number of BLOBs with low request rates. For these BLOBs, triple replication results in over provisioning

from a throughput perspective. Yet, triple replication also provided important fault tolerance guarantees.

Our newer f4 BLOB storage system provides the same fault tolerance guarantees as Haystack but at a lower effective-replication-factor. f4 is simple, modular, scalable, and fault tolerant; it handles the request rate of BLOBs we store it in; it responds to requests with sufficiently low latency; it is tolerant to disk, host, rack and datacenter failures; and it provides all of this at a low effective-replication-factor.

We describe f4 as a *warm* BLOB storage system because the request rate for its content is lower than that for content in Haystack and thus is not as “hot.” Warm is also in contrast with cold storage systems [20, 40] that reliably store data but may take days or hours to retrieve it, which is unacceptably long for user-facing requests. We also describe BLOBs using temperature, with hot BLOBs receiving many requests and warm BLOBs receiving few.

There is a strong correlation between the age of a BLOB and its temperature, as we will demonstrate. Newly created BLOBs are requested at a far higher rate than older BLOBs. For instance, the request rate for week-old BLOBs is an order of magnitude lower than for less-than-a-day old content for eight of nine examined types. In addition, there is a strong correlation between age and the deletion rate. We use these findings to inform our design: the lower request rate of warm BLOBs enables us to provision a lower maximum throughput for f4 than Haystack, and the low delete rate for warm BLOBs enables us to simplify f4 by not needing to physically reclaim space quickly after deletes. We also use our finding to identify warm content using the correlation between age and temperature.

Facebook’s overall BLOB storage architecture is designed to enable warm storage. It includes a caching stack that significantly reduces the load on the storage systems and enables them to be provisioned for fewer requests per BLOB; a transformer tier that handles computational-intense BLOB transformation and can be scaled independently of storage; a router tier that abstracts away the underlying storage systems and enables seamless migration between them; and the hot storage system, Haystack, that aggregates newly created BLOBs into volumes and stores them until their request and delete rates have cooled off enough to be migrated to f4.

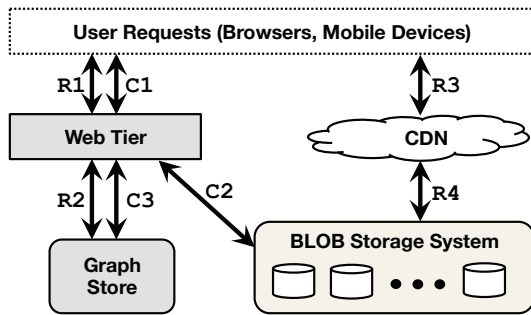

Figure 1: Reading (R1–R4) and creating (C1–C3) BLOBs.

f4 stores volumes of warm BLOBs in cells that use distributed erasure coding, which uses fewer physical bytes than triple replication. It uses Reed-Solomon(10,4) [46] coding and lays blocks out on different racks to ensure resilience to disk, machine, and rack failures within a single datacenter. It uses XOR coding in the wide-area to ensure resilience to datacenter failures. f4 has been running in production at Facebook for over 19 months. f4 currently stores over 65PB of logical data and saves over 53PB of storage.

Our contributions in this paper include:

- A case for warm storage that informs future research on it and justifies our efforts.
- The design of our overall BLOB storage architecture that enables warm storage.
- The design of f4, a simple, efficient, and fault tolerant warm storage solution that reduces our effective-replication-factor from 3.6 to 2.8 and then to 2.1.
- A production evaluation of f4.

The paper continues with background in Section 2. Section 3 presents the case for warm storage. Section 4 presents the design of our overall BLOB storage architecture that enables warm storage. f4 is described in Section 5. Section 6 covers a production evaluation of f4, Section 7 covers lessons learned, Section 8 covers related work, and Section 9 concludes.

## 2. Background

This section explains where BLOB storage fits in the full architecture of Facebook. It also describes the different types of BLOBs we store and their size distributions.

### 2.1 Where BLOB Storage Fits

Figure 1 shows how BLOB storage fits into the overall architecture at Facebook. BLOB creates—e.g., a video upload—originate on the web tier (C1). The web tier writes the data to the BLOB storage system (C2) and then stores the handle for that data into our graph store (C3), Tao [9]. The handle can be used to retrieve or delete

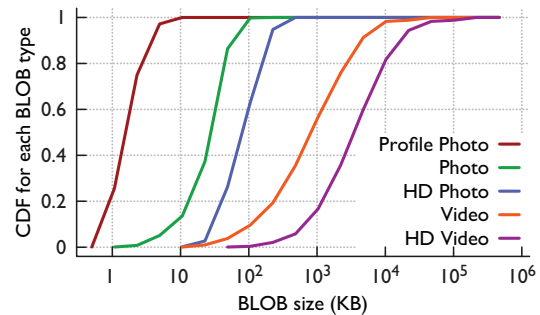

Figure 2: Size distribution for five BLOB types.

the BLOB. Tao associates the handle with other elements of the graph, e.g., the owner of a video.

BLOB reads—e.g., watching a video—also originate on the web tier (R1). The web tier accesses the Graph Store (R2) to find the necessary handles and constructs a URL that can be used to fetch the BLOB. When the browser later sends a request for the BLOB (R3), the request first goes to a content distribution network (CDN) [2, 34] that caches commonly accessed BLOBs. If the CDN does not have the requested BLOB, it sends a request to the BLOB storage system (R4), caches the BLOB, and returns it to the user. The CDN shields the storage system from a significant number of requests on frequently accessed data, and we return to its importance in Sections 4.1.

### 2.2 BLOBs Explained

BLOBs are immutable binary data. They are created once, read potentially many times, and can only be deleted, not modified. This covers many types of content at Facebook. Most BLOB types are user facing, such as photos, videos, and documents. Other BLOB types are internal, such as traces, heap dumps, and source code. User-facing BLOBs are more prevalent so we focus on them for the remainder of the paper and refer to them as simply BLOBs.

Figure 2 shows the distribution of sizes for five types of BLOBs. There is a significant amount of diversity in the sizes of BLOBs, which has implications for our design as discussed in Section 5.6.

## 3. The Case for Warm Storage

This section motivates the creation of a warm storage system at Facebook. It demonstrates that temperature zones exist, age is a good proxy for temperature, and that warm content is large and growing.

**Methodology** The data presented in this section is derived from a two-week trace, benchmarks of existing systems, and daily snapshots of summary statistics. The trace includes a random 0.1% of reads, 10% of creates, and 10% of deletes.

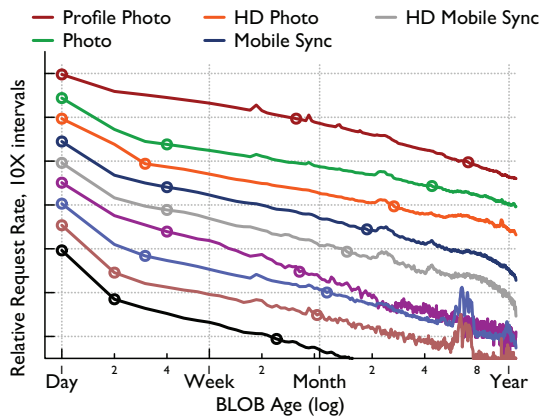

Figure 3: Relative request rates by age. Each line is relative to only itself, absolute values have been denormalized to increase readability, and points mark an order-of-magnitude decrease in request rate.

Data is presented for nine user-facing BLOB types. We exclude some data types from some analysis due to incomplete logging information.

The nine BLOB types include Profile Photos, Photos, HD Photos, Mobile Sync Photos [17], HD Mobile Sync Photos, Group Attachments [16], Videos, HD Videos, and Message (chat) Attachments. Group Attachments and Message Attachments are opaque BLOBs to our storage system, they can be text, pdfs, presentation, etc.

**Temperature Zones Exist** To make the case for warm storage we first show that temperature zones exist, i.e., that content begins as hot, receiving many requests, and then cools over time, receiving fewer and fewer requests.

Figure 3 shows the relative request rate, requests-per-object-per-hour, for content of a given age. The two-week trace of 0.1% of reads was used to create this figure. The age of each object being read is recorded and these are bucketed into 1-day intervals. We then count the number of requests to the daily buckets for each hour in the trace and report the mean—the medians are similar but noisier. Absolute values are denormalized to increase readability so each line is relative to only itself. Points mark order-of-magnitude decreases.

The existence of temperature zones is clear in the trend of decreasing request rates over time. For all nine types, content less than one day old receives more than 100 times the request rate of one-year-old content. For eight of the types the request rate drops by an order of magnitude in less than a week, and for six of the types the request rate drops by 100x in less than 60 days.

**Differentiating Temperature Zones** Given that temperature zones exist, the next questions to answer are how to differentiate warm from hot content and when it is safe to move content to warm storage. We define the

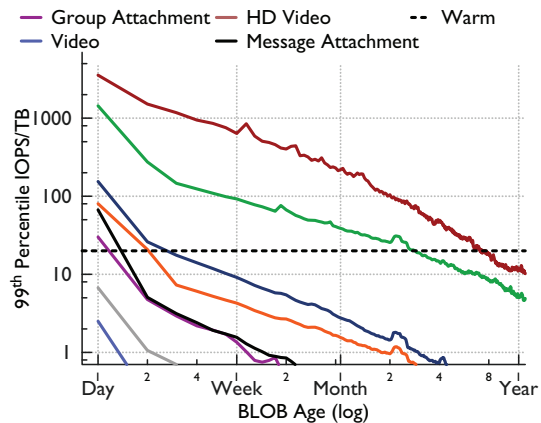

Figure 4: 99th percentile load in IOPS/TB of data for different BLOB types for BLOBs of various ages.

*warm temperature zone* to include unchanging content with a low request rate. BLOBs are not modified, so the only changes are the deletes. Thus, differentiating warm from hot content depends on the request and delete rates.

First, we examine the request rate. To determine where to draw the line between hot and warm storage we consider near-worst-case request rates because our internal service level objects require low near-worst-case latency during our busiest periods of the day.

Figure 4 shows the 99th percentile or near-worst-case request load for BLOBs of various types grouped by age. The two-week trace of 0.1% of reads was used to create this figure. The age of each object read is recorded and these are bucketed into intervals equivalent to the time needed to create 1 TB of that BLOB type. For instance, if 1 TB of a type is created every 3600 seconds, then the first bucket is for ages of 0-3599 seconds, the second is for 3600-7200 seconds, and so on.<sup>1</sup> We then compensate for the 0.1% sampling rate by looking at windows of 1000 seconds. We report the 99th percentile request rate for these windows, i.e., we report the 99th percentile count of requests in a 1000 second window across our two-week trace for each age bucket. The 4TB disks used in f4 can deliver a maximum of 80 Input/Output Operations Per Second (IOPS) while keeping per-request latency acceptably low. The figure shows this peak warm storage throughput at 20 IOPS/TB.

For seven of the nine types the near-worst-case throughput is below the capacity of the warm storage system in less than a week. For Photos, it takes ~3 months to drop below the capacity of warm storage and for Profile Photos it takes a year.

We also examined, but did not rigorously quantify, the deletion rate of BLOB types over time. The general trend

<sup>1</sup> We spread newly created BLOBs over many hosts and disks, so no host or disk in our system is subject to the extreme loads on far left of Figure 4. We elaborate on this point further in Section 5.6

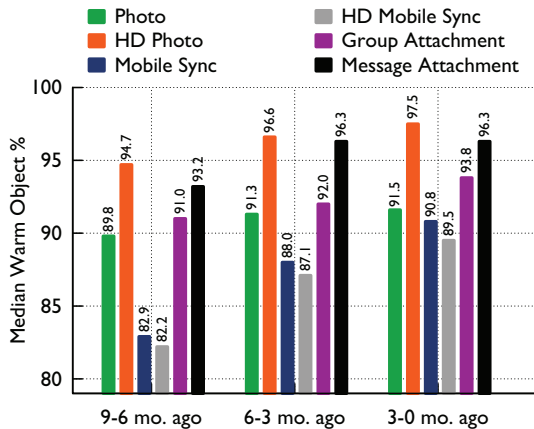

Figure 5: Median percentage of each type that was warm 9-6 months ago, 6-3 months ago, 3 months ago to now. The remaining percentage of each type is hot.

is that most deletes are for young BLOBs and that once the request rate for a BLOB drops below the threshold of warm storage, the delete rate is low as well.

Combining the deletion analysis with the request rate analysis yields an age of a month as a safe delimiter between hot and warm content for all but two BLOB types. One type, Profile Photos, is not moved to warm storage. The other, Photos, uses a three months threshold.

**Warm Content is Large and Growing** We finish the case for warm storage by demonstrating that the percentage of content that is warm is large and continuing to grow. Figure 5 gives the percentage of content that is warm for three-month intervals for six BLOB types.

We use the above analysis to determine the warm cutoff for each type, i.e., one month for most types. This figure reports the median percentage of content for each type that is warm in three-month intervals from 9-6 months ago, 6-3 months ago, and 3 months ago to now.

The figure shows that warm content is a large percentage of all objects: in the oldest interval more than 80% of objects are warm for all types. It also shows that the warm fraction is increasing: in the most recent interval more than 89% of objects are warm for all types.

This section showed that temperature zones exist, that the line between hot and warm content can safely be drawn for existing types at Facebook at one month for most types, and that warm content is a large and growing percentage of overall BLOB content. Next, we describe how Facebook’s overall BLOB storage architecture enables warm storage.

## 4. BLOB Storage Design

Our BLOB storage design is guided by the principle of keeping components simple, focused, and well-matched to their job. In this section we explain volumes, describe

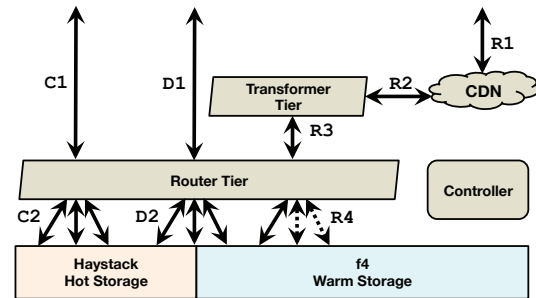

Figure 6: Overall BLOB Storage Architecture with creates (C1-C2), deletes (D1-D2), and reads (R1-R4). Creates are handled by Haystack, most deletes are handled by Haystack, reads are handled by either Haystack or f4.

the full design of our BLOB storage system, and explain how it enables focused and simple warm storage with f4.

**Volumes** We aggregate BLOBs together into logical volumes. Volumes aggregate filesystem metadata, allowing our storage systems to waste few IOPS as we discuss further below. We categorize logical volumes into two classes. Volumes are initially *unlocked* and support reads, creates (appends), and deletes. Once volumes are full, at around 100GB in size, they transition to being *locked* and no longer allow creates. Locked volumes only allow reads and deletes.

Each volume is comprised of three files: a data file, an index file, and a journal file. The data file and index files are the same as the published version of Haystack [5], while the journal file is new. The *data* file holds each BLOB along with associated metadata such as the key, the size, and checksum. The *index* file is a snapshot of the in-memory lookup structure of the storage machines. Its main purpose is allowing rebooted machines to quickly reconstruct their in-memory indexes. The *journal* file tracks BLOBs that have been deleted; whereas in the original version of Haystack, deletes were handled by updating the data and index files directly. For locked volumes, the data and index files are read-only, while the journal file is read-write. For unlocked volumes, all three files are read-write.

### 4.1 Overall Storage System

The full BLOB storage architecture is shown in Figure 6. Creates enter the system at the router tier (C1) and are directed to the appropriate host in the hot storage system (C2). Deletes enter the system at the router tier (D1) and are directed to the appropriate hosts in appropriate storage system (D2). Reads enter the system at the caching stack (R1) and, if not satisfied there, traverse through the transformer tier (R2) to the router tier (R3) that directs them to the appropriate host in the appropriate storage system (R4).

**Controller** The controller ensures the smooth functioning of the overall system. It helps with provisioning new store machines, maintaining a pool of unlocked volumes, ensuring that all logical volumes have enough physical volumes backing them, creating new physical volumes if necessary, and performing periodic maintenance tasks such as compaction and garbage collection.

**Router Tier** The router tier is the interface of BLOB storage; it hides the implementation of storage and enables the addition of new subsystems like f4. Its clients, the web tier or caching stack, send operations on logical BLOBs to it.

Router tier machines are identical, they execute the same logic and all have soft state copies of the logical-volume-to-physical-volume mapping that is canonically stored in a separate database (not pictured). The router tier scales by adding more machines and its size is independent of the other parts of the overall system.

For reads, a router extracts the logical volume id from the BLOB id and finds the physical mapping of that volume. It chooses one of available physical volumes—typically, the volume on the closest machine—and sends the request to it. In case of failure, a timeout fires and the request is directed to the next physical volume.

For creates, the router picks a logical volume with available space, and sends the BLOB out to all physical volumes for that logical volume. In case of any errors, any partially written data is ignored to be garbage collected later, and a new logical volume is picked for the create.

For deletes, the router issues deletes to all physical replicas of a BLOB. Responses are handled asynchronously and the delete is continually retried until the BLOB is fully deleted in case of failure.

The router tier enables warm storage by hiding the storage implementation from its clients. When a volume is migrated from the hot storage system to the warm storage system it temporarily resides in both while the canonical mapping is updated and then client operations are transparently directed to the new storage system.

**Transformer Tier** The transformer tier handles a set of transformations on the retrieved BLOB. For example, these transformations include resizing and cropping photos. In Facebook’s older system, these computational intensive transformations were performed on the storage machines.

The transformer tier enables warm storage by freeing the storage system to focus solely on providing storage. Separating computation into its own tier allows us to scale out the storage tier and the transformer tier independently. In turn, that allows us to match the size of the storage tiers precisely to our needs. Furthermore, it enables us to choose more optimal hardware for each of these tasks. In particular, storage nodes can be designed

to hold a large number of disks with only a single CPU and relatively little RAM.

**Caching Stack** BLOB reads are initially directed to the caching stack [2, 34] and if a BLOB is resident in one of the caches it is returned directly, avoiding a read in the storage system. This absorbs reads for popular BLOBs and decreases the request rate at the storage system. The caching stack enables warm storage by lowering its request rate.

**Hot Storage with Haystack** Facebook’s hot storage system, Haystack, is designed to use only fully-utilized IOPS. It enables warm storage by handling all BLOB creates, handling most of the deletes, and handling a higher read rate.

Haystack is designed to fully utilize disk IOPS by:

- **Grouping BLOBs:** It creates only a small number (~100) of files with BLOBs laid out sequentially in those files. The result is a simple BLOB storage system that uses a small number of files, and bypasses the underlying file system for most metadata access.
- **Compact metadata management:** It identifies the minimal set of metadata that is needed to locate each BLOB and carefully lays out this metadata so that it fits in the available memory on the machine. This allows the system to waste very few IOPS for metadata fetches.

BLOBs are grouped into *logical volumes*. For fault tolerance and performance, each logical volume maps into multiple *physical volumes* or replicas on different hosts across different geographical regions: all physical volumes for a logical volume store the same set of BLOBs. Each physical volume lives entirely on one Haystack host. There are typically 3 physical volumes for each logical volume. Each volume holds up to millions of immutable BLOBs, and can grow to ~100GB in size.

When a host receives a read it looks up the relevant metadata—the offset in the data file, the size of the data record, and whether it has been deleted—in the in-memory hash table. It then performs a single I/O request to the data file to read the entire data record.

When a host receives a create it synchronously appends a record to its physical volume, updates the in-memory hash tables, and synchronously updates the index and journal files.

When a host receives a delete it updates the its in-memory hash tables and the journal file. The contents of the BLOB still exist in the data file. Periodically we *compact* volumes, which completely deletes the BLOB and reclaims its space.

**Fault tolerance** Haystack has fault tolerance to disk, host, rack, and datacenter failure through triple replication of data files and hardware RAID-6 (1.2X replication).

Two replicas of each volume are in a primary datacenter but on different racks, and thus hosts and disks. This provides resilience to disk, host, and rack failure. RAID-6 provides additional protection against disk failure. The third replica is in another datacenter and provides resilience to datacenter failure.

This scheme provides good fault tolerance and high throughput for BLOBs, but at an effective-replication-factor of  $3 * 1.2 = 3.6$ . This is the main limitation of Haystack: it is optimized for IOPS but not storage efficiency. As the case for warm storage demonstrated, this results in significant over replication of many BLOBs.

**Expiry-Driven Content** Some BLOB types have expiration times for their content. For instance, uploaded videos are stored in their original format temporary while they are transcoded to our storage formats. We avoid ever moving this expiry-driven content to f4 and keep it in Haystack. The hot storage system copes with the high delete rate by running compaction frequently to reclaim the now available space.

## 5. f4 Design

This section describes our design goals for warm storage and then describes f4, our warm storage system.

### 5.1 Design Goals

At a high level, we want our warm storage system to provide storage efficiency and to provide fault tolerance so we do not lose data or appear unavailable to our users.

**Storage Efficiency** One of the key goals of our new system is to improve storage efficiency, i.e., reduce the effective-replication-factor while still maintaining a high degree of reliability and performance.

The *effective replication factor* describes the ratio of actual physical size of the data to the logical size stored. In a system that maintains 3 replicas, and uses RAID-6 encoding on each node with 12 disks, the effective replication factor is 3.6.

**Fault Tolerance** Another important goal for our storage system is fault tolerance to a hierarchy of faults to ensure we do not lose data and that storage is always available for client requests. We explicitly consider four types of failures:

1. Drive failures, at a low single digit annual rate.
2. Host failures, periodically.
3. Rack failures, multiple time per year.
4. Datacenter failures, extremely rare and usually transient, but potentially more disastrous.

### 5.2 f4 Overview

f4 is our storage subsystem for warm data. It is comprised of a number of *cells*, where each cell lives entirely

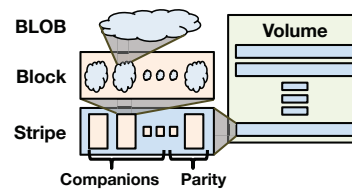

Figure 7: BLOBs in Blocks in Stripes in Volumes.

within one datacenter and is comprised of homogeneous hardware. Current cells use 14 racks of 15 hosts [42] with 30 4TB drives per host. We treat a cell as a unit of acquisition and as a unit of deployment and roll out.

A cell is responsible for reliably storing a set of locked volumes and uses Reed-Solomon coding to store these volumes with lower storage overhead. Distributed erasure coding achieves reliability at lower-storage overheads than replication, with the tradeoff of increased rebuild and recovery times under failure and lower maximum read throughput. *Reed-Solomon coding* [46] is one of the most popular erasure coding techniques, and has been employed in a number of different systems. A Reed-Solomon( $n, k$ ) code encodes  $n$  bits of data with  $k$  extra bits of parity, and can tolerate  $k$  failures, at an overall storage size of  $n + k$ . This scheme protects against disk, host, and rack failures.

We use a separate XOR coding scheme to tolerate datacenter or geographic region failure. We pair each volume/stripe/block with a *buddy* volume/stripe/block in a different geographic region. We store an XOR of the buddies in a third region. This scheme protects against failure of one of the three regions. We discuss fault tolerance in Section 5.5

### 5.3 Individual f4 Cell

Individual f4 cells are resilient to disk, host, and rack failures and are the primary location and interface for the BLOBs they store. Each f4 cell handles only locked volumes, i.e., it only needs to support read and delete operations against that volume. The data and index files are read-only. The haystack journal files that track deletes are not present in f4. Instead, all BLOBs are encrypted with keys that are stored in an external database. Deleting the encryption key for a BLOB in f4 logically deletes it by making it unreadable.

The index files use triple replication within a cell. The files are small enough that the storage gain from encoding them is too small to be worth the added complexity.

The data file with the actual BLOB data is encoded and stored via a Reed-Solomon( $n, k$ ) code. Recent f4 cells use  $n = 10$  and  $k = 4$ . The file is logically divided up into contiguous sequences of  $n$  blocks, each of size  $b$ . For each such sequence of  $n$  blocks,  $k$  parity blocks are generated, thus forming a logical *stripe* of size  $n + k$

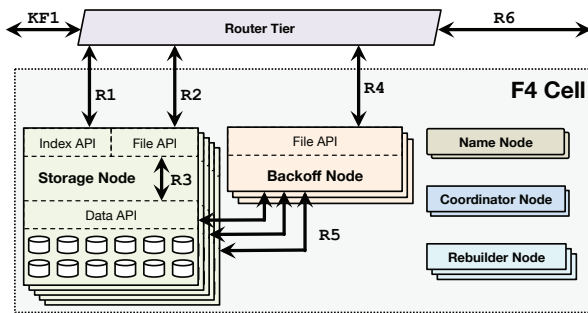

Figure 8: f4 Single Cell Architecture. R1–R3 shows a normal-case read. R1, R4, R5 shows a failure-case read. KF1 shows the encryption key fetch that happens in parallel with the rest of the read path in f4.

blocks. For a given block in a stripe, the other blocks in the stripe are considered to be its *companion* blocks. If the file is not an integral multiple of  $n$  blocks, it is zero-padded to the next multiple. In normal operation BLOBs are read directly from their data block. If a block is unavailable it can be recovered by decoding any  $n$  of its companion and parity blocks. A subset of a block, corresponding to a BLOB, can also be decoded from only the equivalent subsets of any  $n$  of its companion and parity blocks. Figure 7 shows the relationship between BLOBs, blocks, strips, and volumes.

The block-size for encoding is chosen to be a large value—typically 1 GB—for two reasons. First, it decreases the number of BLOBs that span multiple blocks and thus require multiple I/O operations to read. Second, it reduces the amount of per-block metadata that f4 needs to maintain. We avoid a larger block size because of the larger overhead for rebuilding blocks it would incur.

Figure 8 shows a f4 cell. Its components include storage nodes, name nodes, backoff nodes, rebuilder nodes, and coordinator nodes.

**Name Node** The name node maintains the mapping between data blocks and parity blocks and the storage nodes that hold the actual blocks. The mapping is distributed to storage nodes via standard techniques [3, 18]. Name nodes are made fault tolerant with a standard primary-backup setup.

**Storage Nodes** The storage nodes are the main component of a cell and handle all normal-case reads and deletes. Storage nodes expose two APIs: an *Index API* that provides existence and location information for volumes, and a *File API* that provides access to data.

Each node is responsible for the existence and location information of a subset of the volumes in a cell and

exposes this through its *Index API*.<sup>2</sup> It stores the index—BLOB to data file, offset, and length—file on disk and loads them into custom data structures in memory. It also loads the location-map for each volume that maps offsets in data files to the physically-stored data blocks. Index files and location maps are pinned in memory to avoid disk seeks.

Each BLOB in f4 is encrypted with a per-BLOB encryption key. Deletes are handled outside of f4 by deleting a BLOB’s encryption key that is stored in a separate key store, typically a database. This renders the BLOB unreadable and effectively deletes it without requiring the use of compaction in f4. It also enables f4 to eliminate the journal file that Haystack uses to track key presence and deletion information.

Reads (R1) are handled by validating that the BLOB exists and then redirecting the caller to the storage node with the data block that contains the specified BLOB.

The Data API provides data access to the data and parity blocks the node stores. Normal-case reads are redirected to the appropriate storage node (R2) that then reads the BLOB directly from its enclosing data block (R3). Failure-case reads use the Data API to read companion and parity blocks needed to reconstruct the BLOB on a backoff node.

The router tier fetches the per-BLOB encryption key in parallel with the rest of the read path, i.e., R1–R3 or R1, R4, R5. The BLOB is then decrypted on the router tier. Decryption is computationally expensive and performing it on the router tier allows f4 to focus on efficient storage and allows decryption to be scaled independently from storage.

**Backoff Nodes** When there are failures in a cell, some data blocks will become unavailable, and serving reads for the BLOBs it holds will require *online reconstruction* of them from companion data blocks and parity blocks. Backoff nodes are storage-less, CPU-heavy nodes that handle the online reconstruction of request BLOBs.

Each backoff node exposes a *File API* that receives reads from the router tier after a normal-case read fails (R4). The read request has already been mapped to a data file, offset, and length by a primary volume-server. The backoff volume-server sends reads of that length from the equivalent offsets from all  $n - 1$  companion blocks and  $k$  parity blocks for the unavailable block (R5). Once it receives  $n$  responses it decodes them to reconstruct the requested BLOB.

This online reconstruction rebuilds only the requested BLOB, it does not rebuild the full block. Because the size of a BLOB is typically much smaller than the block

<sup>2</sup> Each storage node owns a subset of the volumes in a cell, each volume is owned by exactly one storage node at a time, and all volumes are owned at all times. The volume-to-storage-node assignment is maintained by a separate system that is out of the scope of this paper.

size—e.g., 40KB instead of 1GB—reconstructing the BLOB is much faster and lighter weight than rebuilding the block. Full block rebuilding is handled offline by rebuild nodes.

**Rebuilder Nodes** At large scale, disk and node failures are inevitable. When this happens blocks stored on the failed components need to be rebuilt. Rebuilder nodes are storage-less, CPU-heavy nodes that handle failure detection and background reconstruction of data blocks. Each rebuild node detects failure through probing and reports the failure to a coordinator node. It rebuilds blocks by fetching  $n$  companion or parity blocks from the failed block's strip and decoding them. Rebuilding is a heavy-weight process that imposes significant I/O and network load on the storage nodes. Rebuilder nodes throttle themselves to avoid adversely impacting online user requests. Scheduling the rebuilds to minimize the likelihood of data loss is the responsibility of the coordinator nodes.

**Coordinator Nodes** A cell requires many maintenance tasks, such as scheduling block rebuilding and ensuring that the current data layout minimizes the chances of data unavailability. Coordinator nodes are storage-less, CPU-heavy nodes that handle these cell-wide tasks.

As noted earlier, blocks in a stripe are laid out on different failure domains to maximize reliability. However, after initial placement and after failure, reconstruction, and replacement there can be *violations* where a stripe's blocks are in the same failure domain. The coordinator runs a placement balancer process that validates the block layout in the cell, and rebalance blocks as appropriate. Rebalancing operations, like rebuilding operations, incur significant disk and network load on storage nodes and are also throttled so that user requests are adversely impacted.

## 5.4 Geo-replication

Individual f4 cells all reside in a single datacenter and thus are not tolerant to datacenter failures. To add datacenter fault tolerance we initially double-replicated f4 cells and placed the second replica in a different datacenter. If either datacenter fails, all the BLOBs are still available from the other datacenter. This provides all of our fault tolerance requirements and reduces the effective-replication-factor from 3.6 to 2.8.

Given the rarity of datacenter failure events we sought a solution that could further reduce the effective-replication-factor with the tradeoff of decreased throughput for BLOBs stored at the failed datacenter. We are currently deploying geo-replicated XOR coding that reduces the effective-replication-factor to 2.1.

Geo-replicated XOR coding provides datacenter fault tolerance by storing the XOR of blocks from two different volumes primarily stored in two different datacenters in a third datacenter as shown in Figure 9. Each data

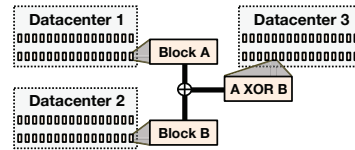

Figure 9: Geo-replicated XOR Coding.

and parity block in a volume is XORed with the equivalent data or parity block in the other volume, called its *buddy block*, to create their *XOR block*. These XOR blocks are stored with normal triple-replicated index files for the volumes. Again, because the index files are tiny relative to the data, coding them is not worth the added complexity.

The 2.1 replication factor comes from the 1.4X for the primary single cell replication for each of two volumes and another 1.4X for the geo-replicated XOR of the two volumes:  $\frac{1.4*2+1.4}{2} = 2.1$ .

Reads are handled by a *geo-backoff node* that receives requests for a BLOB that includes the data file, offset, and length (R6 in Figure 8). This node then fetches the specified region from the local XOR block and the remote XOR-companion block and reconstructs the requested BLOB. These reads go through the normal single-cell read path through storage nodes Index and File APIs or backoff node File APIs if there are disk, host, or rack failures that affect the XOR or XOR-companion blocks.

We chose XOR coding for geo-replication because it significantly reduces our storage requirements while meeting our fault tolerance goal of being able to survive the failure of a datacenter.

## 5.5 f4 Fault Tolerance

Single f4 cells are tolerant to disk, host, and rack failures. Geo-replicating XOR volumes brings tolerance to datacenter failures. This subsection explains the failure domains in a single cell, how f4 lays out blocks to increase its resilience, gives an example of recovery if all four types of failure all affect the same BLOB, and summarizes how all components of a cell are fault tolerant.

**Failure Domains and Block Placement** Figure 10 illustrates how data blocks in a stripe are laid out in a f4 cell. A rack is the largest failure domain and is our primary concern. Given a stripe  $S$  of  $n$  data blocks and  $k$  parity blocks, we attempt to lay out the blocks so that each of these is on a different rack, and at least on a different node. This requires that a cell have at least  $n + k$  racks, of roughly the same size. Our current implementation initially lays out blocks making a best-effort to put each on a different rack. The placement balancer process detects and corrects any rare violations that place a stripe's blocks on the same rack.



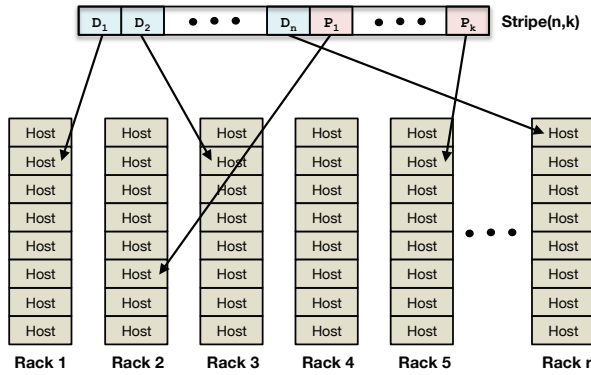

Figure 10: Distributing data & parity blocks in a f4 cell.

Laying blocks for a stripe out on different racks also provide resilience to host and disk failures. Blocks in a stripe on different racks will also be on different hosts and disks.

**Quadruple Failure Example** To illustrate f4’s fault tolerance we examine a case where a failure at all four levels affects a single BLOB. The failures include:

1. Primary cell’s datacenter fails.
2. Data block’s XOR block’s rack fails.
3. One of the parity block’s XOR block’s host fails.
4. Data block’s XOR-companion block’s disk fails.

The router tier will detect the primary’s cell datacenter failure and send a BLOB read request to the XOR datacenter. The BLOB read request will be converted to a data file read request with an offset and length by the Index API on a geo-storage node using the triple-replicated index file in the XOR datacenter. Then a geo-backoff node will fetch the equivalent section of the XOR-data block locally and the buddy block from a third datacenter. The local XOR-data block read will initially fail because its enclosing rack is unavailable. Then the XOR-backoff node reads the XOR-data block through a (regular) backoff node that reconstructs the XOR-data block from  $n$  of its companion and parity blocks. Simultaneously, the remote buddy block read will fail because its enclosing disk failed. A (regular) backoff node in that datacenter will reconstruct the relevant section of buddy block from  $n$  of its companion and parity blocks. The XOR-backoff node will then receive the sections of the XOR-data block and the buddy block, XOR them, and return the BLOB.

**Fault Tolerance for All** Our primary fault tolerance design concern for f4 was providing four level of fault tolerance for data files, the dominant resource for warm BLOB storage, at a low effective-replication-factor. We also require that the other components of a cell be tolerance to the same faults, but use simpler and more

Node	Fault Tolerance Strategy
Name	Primary-backup; 2 backups; different racks.
Coordinator	"
Backoff	Soft state only.
Rebuilder	"
Storage:	
Index	3x local cell; 3x remote cell.
Data	Reed-Solomon local cell; XOR remote cell.

Table 1: Fault tolerance strategy for components of f4.

common techniques because they are not the dominant resource. Table 1 summarizes the techniques we use for fault tolerance for all components of a cell for failures within a cell. We do not provide datacenter fault tolerance for the other components of a cell because they are fate-sharing, i.e., datacenter failures take down entire cells.

## 5.6 Additional Design Points

This subsection briefly covers additional design points we excluded from the basic f4 design for clarity.

**Mixing Age and Types** Our BLOB storage system fills many volumes for each BLOB type concurrently. This mixes the age of BLOBs within a volume and smoothes their temperature. The most recent BLOBs in a volume may have a higher temperature than our target for f4. But, if the older BLOBs in the volume reduce its overall temperature below our target the volume may still be migrated to f4.

Different BLOB types are mixed together on hosts in a f4 cell to achieve a similar effect. High temperature types can be migrated to f4 sooner if they are mixed with low temperature types that will smooth out the overall load on each disk.

**Index Size Consideration** The memory needs of f4 (and Haystack) are primarily driven by the memory footprint of the index. The multiple caching layers in front of f4 obviate the need for a large buffer cache on the storage machine.<sup>3</sup>

Other than for profile photos, the memory sizes for the index fit into the memory in our custom hardware. For profile photos, we currently exclude them from f4 and keep them in Haystack. The index size for profile photos is still problematic for Haystack hosts, even though they store fewer BLOBs than f4 hosts. To keep the index size reasonable we under utilize the storage on the Haystack hosts. This enabled us to keep Haystack simple and does not significantly impact the efficiency of the overall system because there is only a single profile photo per user and they are quite small.

<sup>3</sup> A small buffer cache in Haystack is useful for newly written BLOBs, which are likely to be read and are not yet in the caching stack.

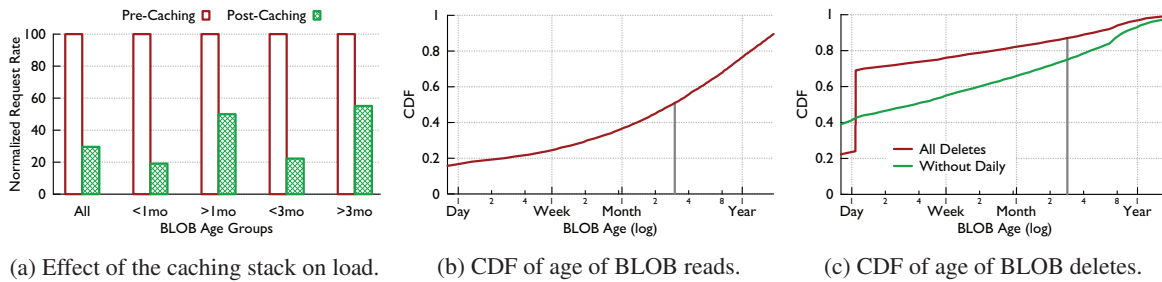

Figure 11: Effects of our general architecture on the workload for f4.

Looking forward, we are evaluating lower-powered CPUs for the storage nodes because the CPU requirements are quite low. Unfortunately, lower powered CPUs usually come with smaller on-board memories. This, coupled with the fact that the drive densities as well as the number of drives per box are increasing, means that the index might not fit in memory for these lower-end configurations. We are exploring storing the index on flash instead of memory for these future configurations.

**Software/Hardware Co-Design** An important consideration in the design of f4 was keeping the hardware and software well matched. Hardware that provides capacity or IOPS that are not used by the software is wasteful; software designed with unrealistic expectations of the hardware will not work. The hardware and software components of f4 were co-designed to ensure they were well-matched by using software measurements to inform hardware choices and vice-versa.

For instance, we measured the candidate hard drives for f4 using a synthetic benchmark to determine the maximum IOPS we could consistently achieve while keeping per-request latency low. We then used these measurements to inform our choice of drives and our provisioning on the software side. The f4 software is designed so the weekly peak load on any drive is less than the maximum IOPS it can deliver.

## 6. Evaluation

This evaluation answers four key questions. Does our overall BLOB storage architecture enable warm storage? Can f4 handle the warm BLOB storage workload’s throughput and latency requirements? Is f4 fault tolerant? And, does f4 save a significant amount of storage?

### 6.1 Methodology

Section 6.4 presents analytic results, all other results in this section are based on data captured from our production systems. The caching stack results in Section 6.2 are based on a day-long trace of 0.5% of BLOB requests routed through Facebook’s caching stack; they do not include results served from browser or device caches. The read/delete results in Section 6.2 are based on a two-

week sample from the router tier of 0.1% of reads and 10% of deletes. The results in Section 6.3 are obtained by dynamically tracking all operations to a uniform sample (0.01%) of all stored content. The storage savings in Section 6.5 are from measurements on a subset of f4.

We measure performance on our production system using a uniform sampling function so multiple generations of our storage machines are reflected in the captured data. Our older storage machines are commodity servers with a quad-core Intel Xeon CPU, 16/24/32 GB of memory, a hardware raid controller with 256-512 byte NVRAM and 12 x 1TB/2TB/3TB SATA drives. More recent machines are custom hosts with an Open Vault 2U chassis holding 30 x 3TB/4TB SATA drives [42]. Haystack uses Hardware RAID-6 with a NVRAM write-back cache while f4 uses these machines in a JBOD (Just a Bunch Of Disks) configuration.

### 6.2 General Architecture Enables Warm Storage

Our general architecture enables our warm storage system in four ways: (1) the caching stack reduces the load on f4; (2) the hot storage system bears the majority of reads and deletes, allowing our warm storage system to focus on efficient storage; (3) the router tier allows us to migrate volumes easily because it is an abstraction layer on top of the physical storage; and (4) the transformer tier allows an independent scaling of processing and storage.

The latter two points (3) and (4) are fundamental to our design. We validate points (1) and (2) experimentally.

**Caching Stack Enables f4** Figure 11a shows the normalized request rate for BLOBs before and after the caching stack for different groups of BLOBs based on age. The Figure shows the caching stack reduces the request rate for all BLOBs to ~30% of what it would have otherwise been. Caching is the most effective for the most popular content, which we expect to be newer content. Thus, we expect the reduction in load from the cache to be less for older content. Our data shows this with the caching stack reducing the request rate to 3+ month old BLOBs to ~55% of its pre-caching volume. This reduction is still significant, however, without it the load for these BLOBs would increase  $\frac{100-55}{55} = 82\%$ .

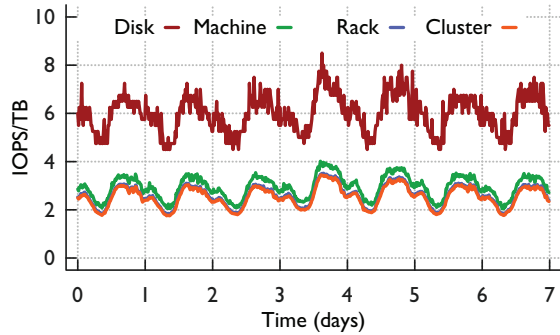

Figure 12: Maximum request rates over a week to f4's most loaded cluster.

**Haystack Enables f4** Figure 11b shows the CDF of the age of read BLOBs. Haystack handles all read requests for BLOBs less than 3 months old and some of the read request for BLOBs older than that.<sup>4</sup> This accounts for more than 50% of the read requests, significantly lowering the load on f4.

Figure 11c shows the CDF of the age of deleted BLOBs. All deletes are plotted, and all deletes excluding those for BLOBs that auto-expire after a day are plotted. Haystack again handles all deletes for content less than 3 months old. Haystack absorbs most BLOB deletes—over 70% of deletes excluding auto-expiry, and over 80% of deletes including auto-expiry—making them less of a concern for f4.

### 6.3 f4 Production Performance

This subsection characterizes f4's performance in production and demonstrated it can handle the warm storage workload and that it provides low latency for reads.

**f4 Handles Peak Load** The IOPS requirement for real-time requests is determined by the peak load rather than average requirement, so we need to look at peak request rates at a fine granularity. Figure 12 shows load in IOPS/TB for the f4 cluster with the highest load over the course of a week. The data is gathered from the 0.1% of reads trace and we compensate for the sampling rate by examining windows of 1000 seconds (instead of 1 second). Our trace identifies only the cluster for each request, so we randomly assign BLOBs to disks and use this assignment to determine the load on disks, machines, and racks. The maximum across all disk, machines, and racks is reported for each time interval.

The figure show the request rate has predictable peaks and troughs that result from different users across the globe accessing the site at different times and this can vary load by almost 2x during the course of a day.

<sup>4</sup> We currently use an approximately 3-month cutoff for all types in production for simplicity. BLOBs older than 3 months can be served by Haystack due to lag in migrations to f4.

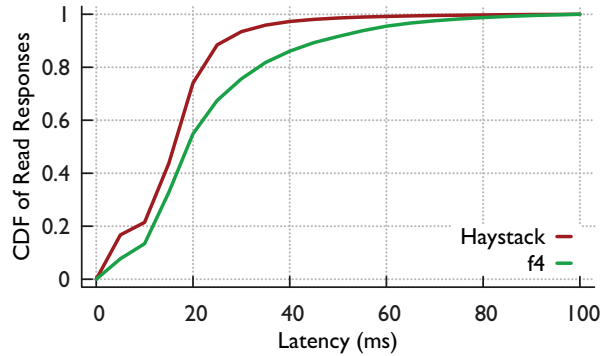

Figure 13: CDF of local read latency for Haystack/f4.

The maximum rack load is indistinguishable from the cluster load in the figure and peaks at 3.5 IOPS/TB during the trace week. The maximum machine load is slightly higher and peaks at 4.1 IOPS/TB. Maximum disk load is notably higher and peaks at 8.5 IOPS/TB. All of these are still less than half the 20 IOPS/TB maximum rate of f4. Even when examining the near-worse-case loads, f4 is able to cope with the lower throughput and decreased variance demands of warm BLOBs.

**f4 Provides Low Latency** Figure 13 shows the same region read latency for Haystack and f4. In our system, most (>99%) of the storage tier read accesses are within the same region. The latencies for f4 reads are higher than those for Haystack, e.g., the median read latency is 14 ms for Haystack and 17 ms for f4. But, the latency for f4 are still sufficiently low to provide a good user experience: the latency for reads in f4 is less than 30 ms for 80% of them and 80 ms for 99% of them.

### 6.4 f4 is Resilient to Failure

f4 is resilient to datacenter failures because we replicate data in multiple geographically distinct locations. Here we verify that f4 is resilient to disk, host, and rack failure.

Our implementation places blocks on different racks initially and continually monitors and rebalances blocks so they are on different racks due to failure. The result is that blocks are almost always in different failure domains, which we assume to be true for the rest of this analysis. Figure 14 shows the CDF of BLOBs that are unavailable if  $N$  disks, hosts, or racks fail in an f4 cell. Worst case, expected case, and best case CDFs are plotted. All results assume we lose some data when there are more than 4 failures in a stripe, though there is work that can recover some of this data [22] we do not implement it. Worst case results assume failures are assigned to one or a small number of blocks first and that parity blocks are the last to fail. Best case results assume failures are assigned to individual racks first and that parity blocks are the first to fail. Non-parity blocks can be used to individually extract the BLOBs they enclose. Expected results are calculated

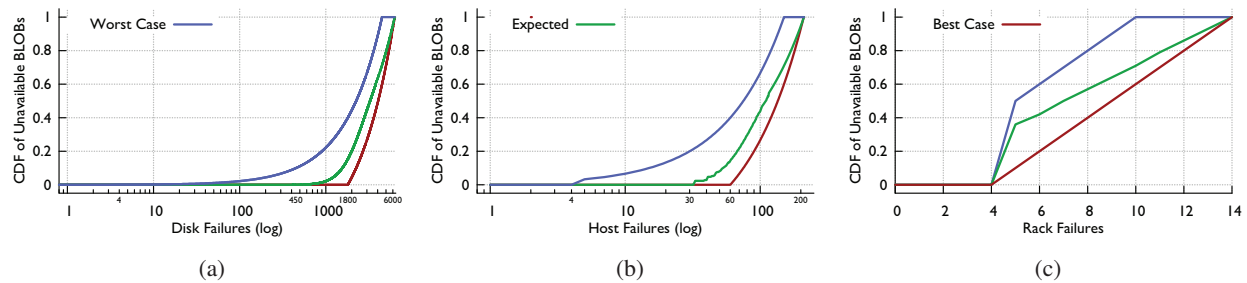

Figure 14: Fraction of unavailable BLOBs for a f4 cell with  $N$  disk, host, and rack failures.

by the Monte Carlo method. There are 30 disks/host, 15 hosts/rack, and 14 racks.

Figure 14a shows the results for  $N$  disk failures. In the worst case there are some unavailable BLOBs after 4 disk failures, 50% unavailable BLOBs after 2250 disk failures, and 100% unavailable BLOBs after 4500 disk failures. In the best case there are no unavailable BLOBs until there are more than 1800 disk failures. In expectation, there will be some unavailable BLOBs after 450 disk failures, and 50% unavailable BLOBs after 3200 disk failures.

Figure 14b shows the results for  $N$  host failures. In the worst case there are unavailable BLOBs after 4 host failures, 50% unavailable BLOBs after 74 host failures, and 100% unavailable BLOBs after 150 host failures. In the best case, there are no unavailable BLOBs until there are more than 60 host failures. In expectation, there will be some unavailable BLOBs with 32 host failures and 50% unavailable BLOBs once there are 100 host failures.

Figure 14c shows the results for  $N$  rack failures. In the worst case there are unavailable BLOBs after 4 rack failures and 100% unavailable BLOBs after 10 rack failures. Even in the best case, there will be some unavailable BLOBs once there are 5 rack failures. In expectation, once there are 7 rack failures 50% of BLOBs will be unavailable. Taken together Figure 14 demonstrates that f4 is resilient to failure.

**Failure Experience** In general, we see an Annualized Failure Rate (AFR) of  $\sim 1\%$  for our disks and they are replaced in less than 3 business days so we typically have at most a few disks out at a time per cluster. We recently received a batch of bad disks and have a higher failure rate for the cluster they are in, as discussed further in Section 7. Even so, we are always on the far left parts of the graphs in Figure 14 where there is no difference between worst/best/expected thus far. Host failures occur less often, though we do not have a rule-of-thumb failure rate for them. Host failures typically do not lose data, once the faulty component is replaced (e.g., DRAM) the host returns with the data still on its disks. Our worst failure thus far has been a self-inflicted drill that rebuilt 2 hosts worth of data (240 TB) in the background over 3

days. The only adverse affect of the drill was an increase in p99 latency to 500ms.

## 6.5 f4 Saves Storage

f4 saves storage space by reducing the effective-replication-factor of BLOBs, but it does not reclaim the space of deleted BLOBs. Thus, the true benefit in reduced storage for f4 must account for the space. We measured the space used for deleted data in f4, which was 6.8%.

Let  $repl_{hay} = 3.6$  be the effective replication factor for Haystack,  $repl_{f4} = 2.8$  or  $2.1$  be the effective replication factor of f4,  $del_{f4} = .068$  the fraction of BLOBs in f4 that are deleted, and  $logical_{f4} > 65PB$  be the logical size of BLOBs stored in f4. Then the reduction in storage space from f4 is:

$$\begin{aligned} \text{Reduction} &= (repl_{hay} - repl_{f4} * \frac{1}{1 - del_{f4}}) * logical_{warm} \\ &= (3.6 - repl_{f4} * 1.07) * 65PB \\ &= 30PB \text{ at } 2.8, 68PB \text{ at } 2.1, 53PB \text{ currently} \end{aligned}$$

With a current corpus over 65 PB, f4 saved over 39 PB of storage at the 2.8 effective-replication-factor and will save over 87 PB of storage at 2.1. f4 currently saves over 53PB with the partial deployment of 2.1.

## 7. Experience

In the course of designing, building, deploying, and refining f4 we learned many lessons. Among these the importance of simplicity for operational stability, the importance of measuring underlying software for your use case's efficiency, and the need for heterogeneity in hardware to reduce the likelihood of correlated failures stand out.

The importance of simplicity in the design of a system for keeping its deployment stable crops up in many systems within Facebook [41] and was reinforced by our experience with f4. An early version of f4 used journal files to track deletes in the same way that Haystack does. This single read-write file was at odds with the rest of the f4 design, which is read-only. The at-most-one-writer requirement of the distributed file system at the heart of

our implementation (HDFS), the inevitability of failure in large distributed systems, and the rarity of writes to the journal file did not play well together. This was the foremost source of production issues for f4. Our later design that removed this read-write journal file pushed delete tracking to another system that was designed to be read-write. This change simplified f4 by making it fully read-only and fixed the production issues.

Measuring and understanding the underlying software that f4 was built on top of helped improve the efficiency of f4. f4's implementation is built on top of the Hadoop File System (HDFS). Reads in HDFS are typically handled by any server in the cluster and then proxied by that server to the server that has the requested data. Through measurement we found that this proxied read has lower throughput and higher latency than expected due to the way HDFS schedules IO threads. In particular, HDFS used a thread for each parallel network IO request and Java's multithreading did not scale well to a large number of parallel requests, which resulted in an increasing backlog of network IO requests. We worked around this with a two-part read, described in Section 5.3, that avoids proxying the read through HDFS. This workaround resulted in the expected throughput and latency for f4.

We recently learned about the importance of heterogeneity in the underlying hardware for f4 when a crop of disks started failing at a higher rate than normal. In addition, one of our regions experienced higher than average temperatures that exacerbated the failure rate of the bad disks. This combination of bad disks and high temperatures resulted in an increase from the normal ~1% AFR to an AFR over 60% for a period of weeks. Fortunately, the high-failure-rate disks were constrained to a single cell and there was no data loss because the buddy and XOR blocks were in other cells with lower temperatures that were unaffected. In the future we plan on using hardware heterogeneity to decrease the likelihood of such correlated failures.

## 8. Related Work

We divide related work into distributed file system, distributed disk arrays, erasure codes, erasure coded storage, hierarchical storage, other related techniques, and BLOB storage systems. f4 is primarily distinguished by its specificity and thus simplicity, and by virtue of it running in production at massive scale across many disk, hosts, racks, and datacenters.

**Distributed File Systems** There are many classic distributed file systems including Cedar [26], Andrew [32], Sprite [39], Coda [48], Harp [38], xfs [3], and Petal [36] among many others. Notable recent examples include the Google File System [18], BigTable [12], and Ceph [53]. All of these file systems are much more general, and thus

necessarily more complex, than f4 whose design was informed by its simpler workload.

**Distributed Disk Arrays** There is also a large body of work on striping data across multiple disks for improved throughput and fault tolerance that was first advocated in a case for RAID [43]. Later work included Zebra [30] that forms of a client's write into a log and stripes them together, similar to how we stripe many BLOBs together in a block. Other work includes disk shadowing [7], maximizing performance in a striped disk array [13], parity declustering [31], parity logging [51], AFRAID [49], TickerTAIP [11], NASD [19], and D-GRAID [50]. Chen et al.'s survey on provides a thorough overview of RAID in practice [14]. f4 continues the tradition of distributing data for reliability, but does so across racks and datacenter as well as disks and hosts.

**Erasure Codes** Erasure codes enjoy a long history starting with the Hamming's original error-correcting code [27]. Our work uses Reed-Solomon codes [46] and XOR codes. EVENODD [8] simplifies error correction using XOR codes. WEAVER codes [24] are a more recent XOR-based erasure code. HoVer codes [25] add parity in two dimensions, similar to our local vs. geo-replicated distinction, though at a much lower level and with more similar techniques. STAIR codes [37] provide fault tolerance to disk sector failures, a level below our currently smallest failure domain. XORing elephants [4] presents a new family of erasure codes that are more efficiently repairable. A hitchhiker's guide to fast and efficient data reconstruction [45] presents new codes that reduce network and disk usage. f4 uses erasure codes as tools and does not innovate in this area.

**Erasure Coded Storage** Plank gave a tutorial on Reed-Solomon codes for error correction in RAID-like systems [44]. f4 implements something similar, but uses checksums colocated with blocks for error detection and uses Reed-Solomon for erasure correction that can tolerate more failures at same parity level. More recent erasure coded storage includes Oceanstore [35], a peer-to-peer erasure coded system. Weatherspoon et al. [52] provide a detailed comparison of replication vs. erasure-coding for peer-to-peer networks. Other systems include Glacier [23] and Ursa Minor [1]. Windows Azure storage [33] uses new Local Reconstruction Codes for efficient recovery with local and global parity information, but is not a Maximum Distance Separable (MDS) code. Our local Reed-Solomon coding is MDS, though the combination with XOR is not.

**Hierarchical Storage** The literature is also rich with work on hierarchical storage that uses different storage subsystems for different working sets. A canonical example is HP AutoRAID [54] that has two levels of storage with replication at the top-level and RAID 5 for the bot-

tom level. HP AutoRAID transparently migrates data between the two levels based on inactivity. The replication our BLOB storage system is similar, though at a far larger scale, for a simpler workload, and with very different migration choices and costs.

**Other Similar Techniques** Our approach of appending new BLOBs to a physical volume resembles log-structured file systems [47], and greatly improves our write latency. Harter et al. [28] analyzed the I/O behavior of *iBench*, a collection of productivity and multimedia applications and observed that many modern applications manage a single file as a mini-filesystem. This is also how we treat our files (including data files, index files and journal files). Copyset replication [15] explores how to group replicas to decrease the likelihood of data loss, but does not use erasure codes.

**BLOB Storage** Our work on warm storage builds on some key ideas from Haystack [5], Facebook’s hot BLOB storage system. Huang et al. [34] performed an extensive study of Facebook photo and found that advanced caching algorithms would increase cache hit ratios and further drive down backend load. If implemented, this could enable faster migration from hot storage to f4. Harter et al. [29] performed a multilayer study of the Facebook Messages stack, which is also built on top of HDFS. Blobstore [6] provides a good overview of Twitter’s in-house photo storage system, but does not describe performance or efficiency aspects in much detail. Microsoft’s Windows Azure Storage [10] is designed to be a generic cloud service while ours is a more specialized application, with more unique challenges as well as optimization opportunities. Their coding techniques are discussed above. Google provides a durable but reduced availability storage service (DRA) on its cloud platform [21], but implementation details are not public and there is no support for migrating groups of objects (buckets) from normal to DRA storage.

## 9. Conclusion

Facebook’s BLOB corpus is massive, growing, and increasingly warm. This paper made a case for a specialized warm BLOB storage system, described an overall BLOB storage system that enables warm storage, and gave the design of f4. f4 reduces the effective-replication-factor of warm BLOBs from 3.6 to 2.1; is fault tolerant to disk, host, rack, and datacenter failures; provides low latency for client requests; and is able to cope with the lower throughput demands of warm BLOBs.

## References

[1] M. Abd-El-Malek, W. V. Courtright II, C. Cranor, G. R. Ganger, J. Hendricks, A. J. Klosterman, M. Mesnier, M. Prasad, B. Salmon, R. R. Sambasivan, S. Sinnamo-hideen, J. D. Strunk, E. Thereska, M. Wachs, and J. J.

Wylie. Ursa minor: Versatile cluster-based storage. In *Proceedings of the USENIX Conference on File and Storage Technologies (FAST)*, 2005.

[2] Akamai. <http://www.akamai.com>.

[3] T. E. Anderson, M. D. Dahlin, J. M. Neefe, D. A. Patterson, D. S. Roselli, and R. Y. Wang. Serverless network file systems. In *Proceedings of the ACM Symposium on Operating Systems Principles (SOSP)*, 1995.

[4] M. Asteris, D. Papailiopoulos, A. G. Dimakis, R. Vadali, S. Chen, and D. Borthakur. Xoring elephants: Novel erasure codes for big data. *Proceedings of the VLDB Endowment (PVLDB)*, 6(5), 2013.

[5] D. Beaver, S. Kumar, H. C. Li, J. Sobel, and P. Vajgel. Finding a needle in haystack: Facebook’s photo storage. In *Proceedings of the Symposium on Operating Systems Design and Implementation (OSDI)*, 2010.

[6] A. Bigian. Blobstore: Twitter’s in-house photo storage system. <http://tinyurl.com/cda5ahq>, 2012.

[7] D. Bitton and J. Gray. Disk shadowing. In *Proceedings of the International Conference on Very Large Data Bases (VLDB)*, 1988.

[8] M. Blaum, J. Brady, J. Bruck, and J. Menon. Evenodd: An efficient scheme for tolerating double disk failures in raid architectures. *IEEE Transactions on Computers*, 44(2), 1995.

[9] N. Bronson, Z. Amsden, G. Cabrera, P. Chakka, P. Dimov, H. Ding, J. Ferris, A. Giardullo, S. Kulkarni, H. Li, M. Marchukov, D. Petrov, L. Puzar, Y. J. Song, and V. Venkataramani. Tao: Facebook’s distributed data store for the social graph. In *Proceedings of the Usenix Annual Technical Conference (ATC)*, 2013.

[10] B. Calder, J. Wang, A. Ogus, N. Nilakantan, A. Skjolsvold, S. McKelvie, Y. Xu, S. Srivastav, J. Wu, H. Simitci, J. Haridas, C. Uddaraju, H. Khatri, A. Edwards, V. Bedekar, S. Mainali, R. Abbasi, A. Agarwal, M. F. u. Haq, M. I. u. Haq, D. Bhardwaj, S. Dayanand, A. Adusumilli, M. McNett, S. Sankaran, K. Manivannan, and L. Rigas. Windows azure storage: A highly available cloud storage service with strong consistency. In *Proceedings of ACM Symposium on Operating Systems Principles (SOSP)*, 2011.

[11] P. Cao, S. B. Lin, S. Venkataraman, and J. Wilkes. The tickertap parallel raid architecture. *ACM Transactions on Computer Systems (TOCS)*, 12(3), 1994.

[12] F. Chang, J. Dean, S. Ghemawat, W. C. Hsieh, D. A. Wallach, M. Burrows, T. Chandra, A. Fikes, and R. E. Gruber. Bigtable: A distributed storage system for structured data. *ACM Transactions of Computer Systems (TOCS)*, 26(2), 2008.

[13] P. M. Chen and D. A. Patterson. Maximizing performance in a striped disk array. In *Proceedings of the Annual International Symposium on Computer Architecture (ISCA)*, 1990.

[14] P. M. Chen, E. K. Lee, G. A. Gibson, R. H. Katz, and D. A. Patterson. Raid: High-performance, reliable secondary storage. *ACM Computing Surveys*, 26(2), 1994.

- [15] A. Cidon, S. Rumble, R. Stutsman, S. Katti, J. Ousterhout, and M. Rosenblum. Copysets: Reducing the frequency of data loss in cloud storage. In *Proceedings of the Usenix Annual Technical Conference (ATC)*, 2013.
- [16] Facebook Groups. Facebook groups. <https://www.facebook.com/help/groups>.
- [17] Facebook Mobile Photo Sync. Facebook mobile photo sync. <https://www.facebook.com/help/photosync>.
- [18] S. Ghemawat, H. Gobioff, and S.-T. Leung. The google file system. In *Proceedings of the nineteenth ACM symposium on Operating systems principles (SOSP)*, 2003.
- [19] G. A. Gibson, D. F. Nagle, K. Amiri, J. Butler, F. W. Chang, H. Gobioff, C. Hardin, E. Riedel, D. Rochberg, and J. Zelenka. A cost-effective, high-bandwidth storage architecture. In *ACM SIGPLAN Notices*, 1998.
- [20] A. Glacier. <https://aws.amazon.com/glacier/>.
- [21] Google. Durable reduced availability storage. <https://developers.google.com/storage/docs/durable-reduced-availability>, 2014.
- [22] V. Guruswami and M. Sudan. Improved decoding of reed-solomon and algebraic-geometry codes. *IEEE Transactions on Information Theory*, 1999.
- [23] A. Haeberlen, A. Mislove, and P. Druschel. Glacier: Highly durable, decentralized storage despite massive correlated failures. In *Proceedings of the Conference on Symposium on Networked Systems Design & Implementation (NSDI)*, 2005.
- [24] J. L. Hafner. Weaver codes: Highly fault tolerant erasure codes for storage systems. In *Proceedings of the USENIX Conference on File and Storage Technologies (FAST)*, 2005.
- [25] J. L. Hafner. Hover erasure codes for disk arrays. In *International Conference on Dependable Systems and Networks (DSN)*, 2006.
- [26] R. Hagmann. Reimplementing the cedar file system using logging and group commit. In *Proceedings of the ACM Symposium on Operating Systems Principles (SOSP)*, 1987.
- [27] R. W. Hamming. Error detecting and error correcting codes. *Bell System technical journal*, 29(2), 1950.
- [28] T. Harter, C. Dragga, M. Vaughn, A. C. Arpaci-Dusseau, and R. H. Arpaci-Dusseau. A file is not a file: Understanding the i/o behavior of apple desktop applications. In *Proc. Symposium on Operating Systems Principles (SOSP)*, 2011.
- [29] T. Harter, D. Borthakur, S. Dong, A. S. Aiyer, L. Tang, A. C. Arpaci-Dusseau, and R. H. Arpaci-Dusseau. Analysis of hdfs under hbase: A facebook messages case study. In *Proceedings of the USENIX Conference on File and Storage Technologies (FAST)*, 2014.
- [30] J. H. Hartman and J. K. Ousterhout. The zebra striped network file system. *ACM Transactions on Computer Systems (TOCS)*, 13(3), 1995.
- [31] M. Holland and G. A. Gibson. Parity declustering for continuous operation in redundant disk arrays. In *Proceedings of the International Conference on Architectural Support for Programming Languages and Operating Systems (ASPLOS)*, 1992.
- [32] J. H. Howard, M. L. Kazar, S. G. Menees, D. A. Nichols, M. Satyanarayanan, R. N. Sidebotham, and M. J. West. Scale and performance in a distributed file system. *ACM Transactions on Computer Systems (TOCS)*, 6(1), 1988.
- [33] C. Huang, H. Simitci, Y. Xu, A. Ogus, B. Calder, P. Gopalan, J. Li, S. Yekhanin, et al. Erasure coding in windows azure storage. In *Proceedings of the Usenix Annual Technical Conference (ATC)*, 2012.
- [34] Q. Huang, K. Birman, R. van Renesse, W. Lloyd, S. Kumar, and H. C. Li. An analysis of facebook photo caching. In *Proceedings of the Symposium on Operating Systems Principles (SOSP)*, Nov. 2013.
- [35] J. Kubiawicz, D. Bindel, Y. Chen, S. Czerwinski, P. Eaton, D. Geels, R. Gummadi, S. Rhea, H. Weatherpoon, W. Weimer, et al. Oceanstore: An architecture for global-scale persistent storage. *ACM Sigplan Notices*, 35(11), 2000.
- [36] E. K. Lee and C. A. Thekkath. Petal: Distributed virtual disks. In *Proceedings of the Architectural support for programming languages and operating systems (ASPLOS)*, 1996.
- [37] M. Li and P. P. C. Lee. Stair codes: A general family of erasure codes for tolerating device and sector failures in practical storage systems. In *Proceedings of the USENIX Conference on File and Storage Technologies (FAST)*, 2014.
- [38] B. Liskov, S. Ghemawat, R. Gruber, P. Johnson, L. Shriram, and M. Williams. Replication in the harp file system. In *Proceedings of the ACM Symposium on Operating Systems Principles (SOSP)*, 1991.
- [39] M. N. Nelson, B. B. Welch, and J. K. Ousterhout. Caching in the sprite network file system. *ACM Transaction on Computer Systems (TOCS)*, 6(1), 1988.
- [40] J. Niccolai. Facebook puts 10,000 blu-ray discs in low-power storage system. <http://tinyurl.com/qx759f4>, 2014.
- [41] R. Nishtala, H. Fugal, S. Grimm, M. Kwiatkowski, H. Lee, H. C. Li, R. McElroy, M. Paleczny, D. Peek, P. Saab, D. Stafford, T. Tung, and V. Venkataramani. Scaling memcache at facebook. In *Proceedings of the USENIX Symposium on Networked Systems Design and Implementation (NSDI)*, 2013.
- [42] Open Compute. Open compute. <http://www.opencompute.org/>.
- [43] D. A. Patterson, G. Gibson, and R. H. Katz. A case for redundant arrays of inexpensive disks (raid). In *Proceedings of the 1988 ACM SIGMOD International Conference on Management of Data*, 1988.
- [44] J. S. Plank et al. A tutorial on reed-solomon coding for fault-tolerance in raid-like systems. *Software: Practice and Experience*, 27(9), 1997.

- [45] K. Rashmi, N. B. Shah, D. Gu, H. Kuang, D. Borthakur, and K. Ramchandran. A hitchhikers guide to fast and efficient data reconstruction in erasure-coded data centers. In *Proceedings of the ACM conference on SIGCOMM*, 2014.
- [46] I. S. Reed and G. Solomon. Polynomial codes over certain finite fields. *Journal of the Society for Industrial and Applied Mathematics*, 8, 1960.
- [47] M. Rosenblum and J. K. Ousterhout. The design and implementation of a log-structured file system. *ACM Transactions of Computer Systems (TOCS)*, 10(1), 1992.
- [48] M. Satyanarayanan, J. J. Kistler, P. Kumar, M. E. Okasaki, E. H. Siegel, and D. C. Steere. Coda: A highly available file system for a distributed workstation environment. *IEEE Transactions on Computers*, 39(4), 1990.
- [49] S. Savage and J. Wilkes. Afraid: A frequently redundant array of independent disks. In *Proceedings of the Usenix Annual Technical Conference (ATC)*, 1996.
- [50] M. Sivathanu, V. Prabhakaran, A. C. Arpaci-Dusseau, and R. H. Arpaci-Dusseau. Improving storage system availability with d-raid. *ACM Transactions on Storage (TOS)*, 1(2), 2005.
- [51] D. Stodolsky, G. Gibson, and M. Holland. Parity logging overcoming the small write problem in redundant disk arrays. In *Proceedings of the Annual International Symposium on Computer Architecture (ISCA)*, 1993.
- [52] H. Weatherspoon and J. D. Kubiatowicz. Erasure coding vs. replication: A quantitative comparison. In *International workshop on Peer-To-Peer Systems (IPTPS)*. 2002.
- [53] S. A. Weil, S. A. Brandt, E. L. Miller, D. D. E. Long, and C. Maltzahn. Ceph: A scalable, high-performance distributed file system. In *In Proceedings of Symposium on Operating Systems Design and Implementation (OSDI)*, 2006.
- [54] J. Wilkes, R. Golding, C. Staelin, and T. Sullivan. The hp autoraid hierarchical storage system. *ACM Transactions on Computer Systems (TOCS)*, 14(1), 1996.