

NOTICE CONCERNING COPYRIGHT RESTRICTIONS

The copyright law of the United States [Title 17, United States Code] governs the making of photocopies or other reproductions of copyrighted material.

Under certain conditions specified in the law, libraries and archives are authorized to furnish a photocopy or other reproduction. One of these specified conditions is that the reproduction is not to be used for any purpose other than private study, scholarship, or research. If a user makes a request for, or later uses, a photocopy or reproduction for purposes in excess of "fair use" that use may be liable for copyright infringement.

The institution reserves the right to refuse to accept a copying order if, in its judgment, fulfillment of the order would involve violation of copyright law. No further reproduction and distribution of this copy is permitted by transmission or any other means.

A NEW METHOD OF SOLVING TRANSPORTATION- NETWORK PROBLEMS

MASAO IRI

Kyushu University

(Received July 22, 1960)

1. INTRODUCTION AND HISTORICAL NOTE

Transportation problems constitute one of the most important and practically useful branches of Operations Research (see, e.g., [1], [2] and [3]). Usually they are formulated as the problem of finding a set of x_{ij} 's ($i=1, 2, \dots, m; j=1, 2, \dots, n$) which minimizes

$$\sum_{i=1}^m \sum_{j=1}^n d_{ij} x_{ij} = z \quad (1.1)$$

subject to the conditions

$$\left. \begin{aligned} \sum_{j=1}^n x_{ij} &= a_i & (i=1, 2, \dots, m), \\ \sum_{i=1}^m x_{ij} &= b_j & (j=1, 2, \dots, n), \\ x_{ij} &\geq 0 & (i=1, 2, \dots, m; \\ & & j=1, 2, \dots, n), \end{aligned} \right\} \quad (1.2)$$

when positive real numbers a_i 's, b_j 's and d_{ij} 's are given, where, because of (1.2), a_i 's and b_j 's must satisfy the following equation:

$$\sum_{i=1}^m a_i = \sum_{j=1}^n b_j \left(= \sum_{i=1}^m \sum_{j=1}^n x_{ij} \right). \quad (1.2')$$

A concrete interpretation to this problem is "determining such a manner of delivering a commodity from m producers to n consumers as minimizes the total cost for delivery, under the circumstances that the i -th of m producers supplies a_i of that commodity, the j -th of n consumers demands b_j , that it costs as much as d_{ij} to deliver the unit amount of the commodity from the i -th producer to the j -th consumer, and, finally, that the whole amount of product must be delivered without residue at the producers or shortage at the consumers".

This type of problems, called the "Hitchcock problems" [1], are

treated in any textbook on Operations Research (see, e.g., [2], [3]), but, hitherto, the stepping-stone method, which is the word-by-word translation of the (revised) simplex method, has almost exclusively been resorted to. As the efficacy of the stepping-stone method largely depends on the choice of the first feasible solution, a number of methods have been proposed to give a good first feasible solution, among which we count "Houthakker's method" [4]. Even if a first feasible solution is fixed, there remains a lot of arbitrariness to approach the optimal solution, the amount of labour needed to attain the optimal solution still remaining undetermined.

Unfortunately, if there is any kind of degeneracy in the problem, it may seriously affect the validity of the method. An example of this is the assignment problem, which it is practically impossible to solve by the stepping-stone method because of the existence of serious degeneracy.

An assignment problem can be regarded as a special case of transportation problems of the Hitchcock type defined above, in which

$$\left. \begin{array}{l} m=n, \\ a_i=b_j=1 \quad \text{for every } i \text{ and } j. \end{array} \right\} \quad (1.3)$$

Although the additional condition that x_{ij} 's should be either 0 or 1 is imposed on an assignment problem, it would automatically be satisfied if we solved the problem by means of the stepping-stone method, and furthermore, it is not so difficult a task to convert an optimal solution not satisfying this condition into the one satisfying it. In general, a basic solution (in the sense of the simplex method) for an assignment problem of order n contains exactly n non-vanishing variables, which number is much smaller than the number $2n-1$ for the case free from degeneracy, indicating the seriousness of degeneracy. Under these circumstances the "Hungarian method", devised by H. W. Kuhn, is ordinarily used to solve assignment problems. This highly exquisite method, however, involves a process which is better performed by human intuition and requires frequent rewriting of the cost matrix (d_{ij}) , the convergence to the optimal solution not being very rapid.

In view of the advantage of the Hungarian method over the stepping-stone method for assignment problems, the generalization of the Hungarian method into the one applicable to the Hitchcock problems

was attempted by L. R. Ford and D. R. Fulkerson, to obtain the primal-dual algorithm for transportation problems (as they call it), which can easily be modified to the case where the capacity restriction such as $c_{ij} \geq x_{ij} \geq 0$ is further imposed [5], [6]. This algorithm was extended by T. Fujisawa [7] and also by Ford and Fulkerson themselves [8], [9] to the transportation problems having network structure. However, when applied to an assignment problem, these methods follow exactly the same process as does the Hungarian method, in approaching the optimal solution, which should naturally be expected from their origin.

The present author, while studying to establish possibly the most general network theory that includes all the existing types of network theories by the aid of topology and the theory of algebras in collaboration with the members of the Research Association of Applied Geometry, Japan, [10], [11], [12], [13], [14], [15], [16], happened to find a method which is very convenient to treat various linear-programming problems on a transportation network consisting of transportation routes connected with one another in a general way and each endowed both with a capacity restriction (that the amount of flow through the route should lie between a pair of prescribed values) and with a cost characteristic (i.e. the cost for the unit amount of flow to flow through the route). From the point of view of linear programming only, this method may be regarded as the one obtained from the method of Ford, Fulkerson and Fujisawa by improving the process of determining the dual variables, but, it has many other merits owing to its topological background. (For example, it gives the way much simpler than the Hungarian method when applied to an assignment problem.)

To devise a new method is one thing, but to explain it is another. Therefore, in the sequel, we try to explain the method avoiding, as far as possible, reference to the general network theory from which it originated. For the algebraic and topological foundations of the general network theory of which the theory of transportation network expounded in this paper is a special case, see the above-mentioned references [10] ~ [16].

2. PROBLEM

Let us first define the type of problems to be treated in the follow-

ing.

2.1. Constituents of a transportation network. By a "transportation network" we mean a network (one-dimensional complex or linear graph) consisting of "branches" or transportation routes (denoted by $\sigma_1^1, \sigma_2^1, \sigma_3^1, \dots, \sigma_n^1$, or in general, by σ_κ^1 or σ_λ^1) and "nodes" (denoted by $\sigma_1^0, \sigma_2^0, \sigma_3^0, \dots, \sigma_m^0$, or in general, by σ_a^0 or σ_b^0) which are the junction points of branches. In the following we assume the number of branches as n and that of nodes as m . Each branch has its proper orientation, which is usually indicated by an arrow drawn by its side. The manner in which "branches" are connected with one another is completely expressed by the n -by- m "incidence matrix" ($[\sigma_\kappa^1: \sigma_a^0]$) (whose elements are called "incidence numbers") which is defined as follows:

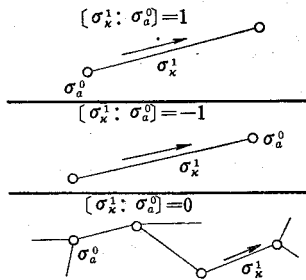

if σ_κ^1 (branch κ) issues from σ_a^0 (node a),

if σ_κ^1 terminates at σ_a^0 ,

otherwise, i.e. if σ_a^0 is not an end point of σ_κ^1 .

The incidence numbers satisfy the relation:

$$\sum_{\kappa=1}^n [\sigma_\kappa^1: \sigma_a^0] = 0 \quad \text{for every } a, \quad (2.1.1)$$

since, to each branch, one and only one node is incident with the incidence number $+1$ and one and only one with -1 .

Through branches of a transportation network, commodity is transported, which fact we shall state simply as "a certain amount of current flows through a branch". (It is only for convenience' sake to adopt here electric terminology such as "current". Nothing will be borrowed from electric network theory in the following treatment. But those who are accustomed to electric networks will easily understand the intuitive meaning of our terminology.) Let us then denote the amount of current flowing through σ_κ^1 (i.e. branch κ or the κ -th branch) by s_κ .

In addition to its proper orientation, each branch has its own characteristics, which are

- (i) capacity restriction¹⁾: a number c^κ (called "capacity") is associated with branch κ so that s^κ should be subject to the restriction

$$c^\kappa \geq s^\kappa \geq 0, \tag{2.1.2}$$

where c^κ may be infinity but must be positive ($c^\kappa < 0$ is impossible by (2.1.2) and if $c^\kappa = 0$, i.e. $s^\kappa \equiv 0$, then we shall exclude the branch from consideration),

and

- (ii) cost characteristic: a number e_κ (called "cost" per unit flow) is associated with branch κ so that it costs as much as $e_\kappa s^\kappa$ for the amount s^κ of current to flow through branch κ , where

$$\infty > e_\kappa \geq 0. \tag{2.1.3}^{2)}$$

2.2. Definition of the general transportation-network problem.

The problem we shall deal with in the sequel is of very general kind as follows.

- (i) Suppose given a transportation network.
- (ii) We arbitrarily choose a pair of nodes of the network and call one of them the "input node", and the other the "output node". We shall hereafter denote them by σ_1^0 and σ_m^0 (the first and the last node), respectively.
- (iii) Branch currents s^κ 's must satisfy the following conditions:

$$\sum_{\kappa=1}^n [\sigma_\kappa^1 : \sigma_a^0] s^\kappa = 0 \quad (a=2, 3, \dots, m-1), \tag{2.2.1}$$

and the "input (output) current flowing into the input node σ_1^0 (out of the output node σ_m^0)" (which we shall denote by s) is defined by

- 1) The lower bound for s^κ need not necessarily be equal to 0 (however, then, $c^\kappa \leq 0$ may have significance), but, as will be done in § 4.7, the extension to that case is easily made.
- 2) This restriction is not essential, for we may exclude the branches for which $e_\kappa = \infty$ on the one hand, and on the other, if $e_\kappa < 0$, we may reverse the orientation of branch κ (then capacity restriction will become such as $-c^\kappa \leq s^\kappa \leq 0$, which case, however, will be treated in § 4.7; cf. footnote 1).

$$s = \sum_{\kappa=1}^n [\sigma_{\kappa}^1 : \sigma_{\kappa}^0] s^{\kappa} = - \sum_{\kappa=1}^n [\sigma_{\kappa}^1 : \sigma_{\kappa}^0] s^{\kappa}. \quad (2.2.2)$$

(2.2.1) and (2.2.2) represent the continuity of current at each node, while the second equality of (2.2.2) follows from (2.2.1) and (2.1.1). (To see this, decompose the identity which follows from (2.1.1):

$$\sum_{\kappa=1}^n \left(\sum_{\alpha=1}^m [\sigma_{\kappa}^1 : \sigma_{\alpha}^0] \right) s^{\kappa} = 0$$

into $\sum_{\alpha=2}^{m-1} \sum_{\kappa=1}^n [\sigma_{\kappa}^1 : \sigma_{\alpha}^0] s^{\kappa}$ and the sum of the second and the third member of (2.2.2).)

- (iv) To a given value of s may correspond more than one set of values of s^{κ} 's which satisfy capacity restrictions, (2.2.1) and (2.2.2), among which there exists at least one such that the total cost for it

$$f = \sum_{\kappa=1}^n e_{\kappa} s^{\kappa} \quad (2.2.3)$$

is not greater than that for any other. Let us call such a set of s^{κ} 's a "minimum-cost" current configuration corresponding to the given value of s . If there exists any current configuration at all satisfying capacity restrictions, (2.2.1) and (2.2.2) for a given s , the minimum f is uniquely determined because always $f \geq 0$. But, note that it may happen that there is no such current configuration for some value of s .

- (v) Finally, the general transportation-network problem is defined as that of determining the relation between s (≥ 0)³⁾ and the corresponding minimum f as well as the current configurations which give the minimum f for possible values of s .

2.3. Electric model of a transportation network. Some people will find it advantageous from the intuitive viewpoint to consider transportation-network problems by the help of an electric circuit model. So, the following analogy will be effective. (Cf. also reference [17].)

3) This is not restrictive, for, if $s < 0$ has to be considered, we may interchange the rôle of the input and the output node.

Considering an electric circuit whose branches are mutually connected in entirely the same way as those of the transportation network, we make electric current in the model circuit correspond to current in the transportation network. Then (2.2.1) and (2.2.2) are no other than the Kirchoff law for electric current. In order to take account of capacity restriction, we assume that such a black box as has the voltage~current relation of Fig. 2.3.1 is contained in each branch. According to this relation, $s^x < 0$ and $s^x > c^x$ are inhibited by the unboundedly large resistance at $s^x = 0$ and $s^x = c^x$, while current can flow without resistance if $0 \leq s^x \leq c^x$.

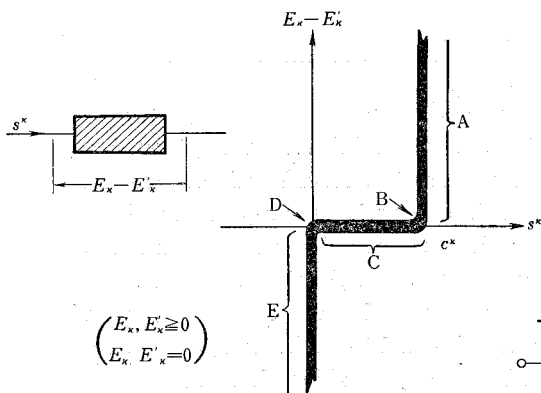

Fig. 2.3.1

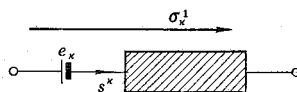

Fig. 2.3.2

For the purpose later becoming clear, we express the voltage across the black box as the difference of two non-negative quantities E_x and E'_x . Because of the condition $E_x, E'_x = 0$, the expression is uniquely determined. As the representative of the cost characteristic of a branch we assume an ideal cell (or battery) with electromotive force e_x to be connected in series to the black box (see Fig. 2.3.2), so that the total power entering the cells is equal to $f = \sum_{\kappa=1}^n e_\kappa s^\kappa$.

Then, the general transportation-network problem is, in electrical terminology, to obtain the relation between the total power and the amount of electric current injected from outside as well as the respec-

tive current configurations, because the minimization of the total power is automatically achieved in an electric circuit (Fig. 2.3.3).

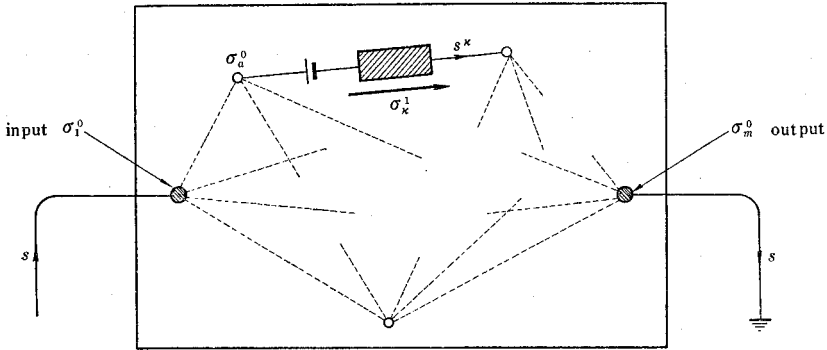

Fig. 2.3.3

The above model is, however, established merely for the purpose of making it easier to understand the essence of the problem and *no knowledge* about electric circuit theory is presupposed in the following treatment. But, the electric circuit model has more than mere analogy concerning the problem. Indeed, it is completely equivalent to a transportation network in the sense that, under the above correspondence of various concepts in electric circuits and those in transportation networks, everything appearing in the following consideration about the transportation-network problem has always its proper correspondent in the electric circuit problem, thus allowing us to regard the following theory as the theory of non-linear electric circuits of a special kind.

2.4. Generality of the problem. In this section it is shown that the general transportation-network problem contains various kinds of practical transportation problems as special cases.

2.4.1. Capacitated Hitchcock problem:—The transportation problem of the type defined by (1.1) and (1.2) and further subjected to the restrictions:

$$0 \leq x_{ij} \leq c_{ij} \quad (2.4.1)$$

can be interpreted as a type of general transportation-network problem in which the structure of the network is as shown in Fig. 2.4.1 [5], [6], [13].

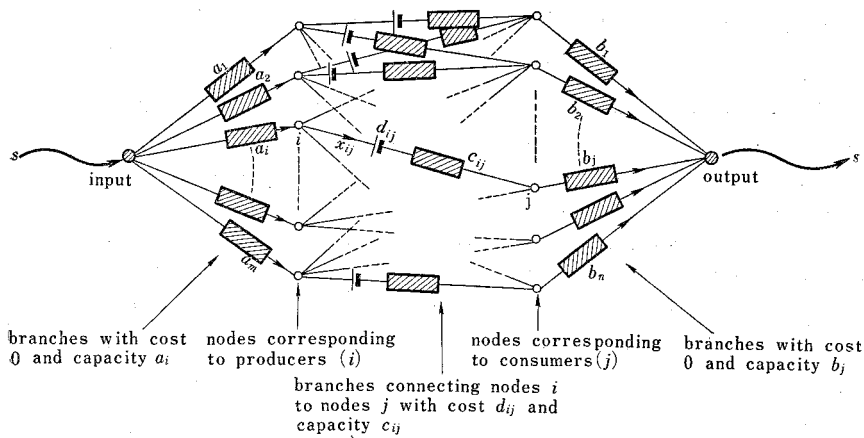

Fig. 2.4.1. Capacitated Hitchcock Problem

If, from the solution of the general transportation-network problem for the network of Fig. 2.4.1, we select a current configuration which corresponds to the maximum s (input-output current), the values x_{ij} 's of the current through the central group of branches of Fig. 2.4.1 will obviously satisfy (1.2) and (2.4.1) with the minimum total cost so long as (1.2) is compatible with (2.4.1).

2.4.2. Assignment problem:—This is a special case of the previous §2.4.1 as has already been mentioned in §1. But the solution process is extremely simplified for this type (cf. §5.3).

2.4.3. Problem of maximizing the input flow s [5], [12]:—Disregarding the cost characteristics we may solve the general problem and select the current configuration corresponding to the maximum s to obtain the solution for this problem. However, the solution of this problem plays a fundamental rôle in the solution of the general problem as we shall show in the following sections.

2.4.4. Problem of minimizing the total cost under given s on a transportation network:—In order to solve the problem of determining such a current configuration as corresponds to the minimum total cost for a given s , we may only select one current configuration correspond-

ing to the given s from the solution of the general problem. The existence or non-existence of the solution is also obvious from the general problem.

2.4.5. Problem of maximizing the input flow s under a fixed cost:—The problem of maximizing s under the condition that the total cost should not be greater than a certain value can be solved by picking up from the solution of the general problem a current configuration to which the corresponding total cost is equal to the given value. The problem treated in [9] is essentially equivalent to this problem.

2.4.6. Other problems:—Besides the above steady-state or static problems, there exist also dynamical or time-dependent problems, some of which have been proved to be solvable by the help of the solution of the corresponding static problems (see [8]).

Moreover, as will later be shown in §4.7, the generalization to the cases, in which $e_\kappa < 0$ and/or capacity restrictions such as $b^\kappa \leq s^\kappa \leq c^\kappa$ (where b^κ and c^κ are arbitrary numbers) are imposed on branch currents, is easy to make.

3. SOLUTION

First we obtain, in a particular way, a relation between the amount of input current and the corresponding minimum cost as well as the corresponding current configurations, and then prove that the relation thus obtained is the only possible one.

3.1. Dual formulation. Our problem (which we shall call "primal") is to determine

$$\text{the minimum value } f(s) \text{ of } f = \sum_{\kappa=1}^n e_\kappa s^\kappa \text{ for each value of } s, \quad (\text{P1})$$

where s^κ 's and s are subject to the capacity restrictions:

$$0 \leq s^\kappa \leq c^\kappa \quad (0 < c^\kappa \leq \infty) \quad (\text{P2})$$

and satisfy the continuity conditions:

$$\left. \begin{aligned} \sum_{\kappa=1}^n [\sigma_\kappa^1 : \sigma_a^0] s^\kappa &= 0 \quad (a=2, 3, \dots, m-1), \\ s &= \sum_{\kappa=1}^n [\sigma_\kappa^1 : \sigma_1^0] s^\kappa = - \sum_{\kappa=1}^n [\sigma_\kappa^1 : \sigma_m^0] s^\kappa. \end{aligned} \right\} \quad (\text{P3})$$

As an auxiliary means, we introduce dual variables (called "voltages") u_a ($a=1, 2, \dots, m$) and E_κ ($\kappa=1, 2, \dots, n$) defining the "dual

problem" as that of

$$\text{maximizing } g = s(u_1 - u_m) - \sum_{\kappa=1}^n c^\kappa E_\kappa \tag{D1}$$

under the conditions:

$$\left. \begin{aligned} E_\kappa &\geq 0, \\ E'_\kappa &\equiv E_\kappa - \sum_{\alpha=1}^m [\sigma_\kappa^1 : \sigma_\alpha^0] u_\alpha + e_\kappa \geq 0. \end{aligned} \right\} \tag{D2}$$

By virtue of (2.1.1) simultaneous addition of one and the same constant to all u_α 's does not substantially affect the dual problem, so that we shall put, in the following,

$$u_m = 0, \tag{D3}$$

replacing u_1 by u and (D1) by (D1'):

$$g = su - \sum_{\kappa=1}^n c^\kappa E_\kappa. \tag{D1'}$$

For an arbitrary choice of primal variables s^κ (satisfying (P2) and (P3) for a given s) and of dual variables u_α, E_κ (satisfying (D2) and (D3)), the following well-known minimax relation holds:

$$\begin{aligned} f &= \sum_{\kappa=1}^n e_\kappa s^\kappa = \sum_{\kappa=1}^n \left(e_\kappa + E_\kappa - \sum_{\alpha=1}^m [\sigma_\kappa^1 : \sigma_\alpha^0] u_\alpha \right) s^\kappa - \sum_{\kappa=1}^n E_\kappa s^\kappa + \sum_{\kappa=1}^n \sum_{\alpha=1}^m [\sigma_\kappa^1 : \sigma_\alpha^0] u_\alpha s^\kappa \\ &= \sum_{\kappa=1}^n E'_\kappa s^\kappa - \sum_{\kappa=1}^n E_\kappa s^\kappa + su \geq su - \sum_{\kappa=1}^n c^\kappa E_\kappa = g. \end{aligned} \tag{3.1.1}$$

Hence, in particular,

$$\min_{(P2),(P3)} f \geq \max_{(D2),(D3)} g. \tag{3.1.2}$$

Therefore, if we have $f=g$ for a certain choice of s^κ 's and u_α 's, E_κ 's, then that $f(=g)$ will give at the same time $\min f=f(s)$ and $\max g$.

The necessary and sufficient condition for $f=g$ in (3.1.1) is that

$$\left. \begin{aligned} E'_\kappa &= 0 & \text{if } s^\kappa > 0, \\ E_\kappa &= 0 & \text{if } s^\kappa < c^\kappa, \end{aligned} \right\} \tag{3.1.3}$$

which is usually called the "optimality condition". The following condition is equivalent (or contrapositive) to (3.1.3):

$$\left. \begin{aligned} s^\kappa &= 0 & \text{if } E'_\kappa > 0, \\ s^\kappa &= c^\kappa & \text{if } E_\kappa > 0. \end{aligned} \right\} \tag{3.1.3'}$$

We shall call a set of primal variables (i.e. a current configuration) or a set of dual variables (i.e. a voltage configuration) "feasible" if they satisfy (P2) and (P3), or (D2) and (D3), but the adjective "feasible" will be understood unless particular need occurs, since almost all

current or voltage configurations to be considered in the following are feasible. Furthermore, we shall call a current configuration and a voltage configuration "compatible" if they satisfy the optimality condition (3.1.3). It is obvious that, if for a given current configuration a voltage configuration exists which is compatible with it, f corresponding to the current configuration is minimum.

The "state" of a branch is defined according to a given compatible pair of current and voltage configurations, i.e. a branch is said to be in

$$\left. \begin{array}{l} \text{state A if } s^r=c^r, \quad E_r>0, \quad E'_r=0, \\ \text{state B if } s^r=c^r, \quad E_r=0, \quad E'_r=0, \\ \text{state C if } 0<s^r<c^r, \quad E_r=0, \quad E'_r=0, \\ \text{state D if } s^r=0, \quad E_r=0, \quad E'_r=0, \\ \text{state E if } s^r=0, \quad E_r=0, \quad E'_r>0, \end{array} \right\} \quad (3.1.4)$$

with respect to the given current and voltage configurations (cf. Fig. 2.3.1 for the electric model).

Let us first search for compatible pairs of current and voltage configurations with s and u as parameters. As the pair from which we start we may take any compatible pair. For example, we may take the current configuration for which all $s^r=0$ and the voltage configuration for which all $u_a=0$, all $E_r=0$ and every $E'_r=e_r$, since, obviously, these configurations are feasible and compatible, and correspond to $s=u=0$ (cf. (P2), (P3), (D2), (D3)). Thus we have obtained, for $s=0$, $f(0)=0$ as well as the corresponding current configuration.

3.2. Current-increasing step or $\langle C \rangle$ [12]. Let us suppose a compatible pair of current and voltage configurations is given, and try to increase the input current s with the voltage configuration fixed, requiring only such current configurations as are compatible with the given voltage configuration to appear. If we denote the given currents and voltages by

$$s, s^r, u_a (u_1=u, u_m=0), E_r, E'_r, \text{ etc.,}$$

respectively, the conditions for another current configuration ' s^r ' to be feasible and compatible with the given voltage configuration are written as follows:

$$\left. \begin{array}{l} -s^r \leq s^r - s^r \leq c^r - s^r, \\ \sum_{\kappa=1}^m [\sigma_{\kappa}^1 : \sigma_{\kappa}^0] (s^r - s^r) = 0 \quad (a=2, 3, \dots, m-1), \end{array} \right\} \quad (3.2.1)$$

$$\left. \begin{aligned} 's^x - s^x = 's^x - c^x = 0 & \text{ if } E_x > 0, \\ 's^x - s^x = 's^x = 0 & \text{ if } E'_x > 0, \end{aligned} \right\} \quad (3.2.2)$$

with

$$'s - s = \sum_{\kappa=1}^n [\sigma_{\kappa}^1 : \sigma_{\kappa}^0] ('s^x - s^x) = - \sum_{\kappa=1}^n [\sigma_{\kappa}^1 : \sigma_{\kappa}^0] ('s^x - s^x). \quad (3.2.3)$$

In other words, for the *incremental currents* we have

$$\left. \begin{aligned} -s^x \leq \Delta s^x \leq c^x - s^x, \\ \sum_{\kappa=1}^n [\sigma_{\kappa}^1 : \sigma_{\kappa}^0] \Delta s^x = 0 \quad (a=2, 3, \dots, m-1), \end{aligned} \right\} \quad (3.2.1')$$

$$\Delta s^x = 0 \text{ if } E_x > 0 \text{ or } E'_x > 0, \quad (3.2.2')$$

and

$$\Delta s = \sum_{\kappa=1}^n [\sigma_{\kappa}^1 : \sigma_{\kappa}^0] \Delta s^x = - \sum_{\kappa=1}^n [\sigma_{\kappa}^1 : \sigma_{\kappa}^0] \Delta s^x, \quad (3.2.3')$$

where

$$\Delta s^x = 's^x - s^x \text{ and } \Delta s = 's - s. \quad (3.2.4)$$

This means that neither feasibility nor optimality is affected by the superposition of an incremental current configuration Δs^x such that

- (a) $\Delta s^x = 0$ in the branches in state A or E, i.e. these kinds of branches are regarded as open-circuited for incremental currents;
- (b) $-s^x \leq \Delta s^x \leq c^x - s^x$ in the branches in state B, C or D, i.e. these kinds of branches admit incremental current between $-s^x$ and $c^x - s^x$, and, in particular, the branches in state B and D are one-way conductive (respectively, in negative and positive directions), and those in state C are conductive in both directions,

where the names of states are concerned with the given current and voltage configurations (cf. (3.1.4)).

In order to increase the input current as much as possible, we search for a conduction route leading from the input node to the output, i.e. for a sequence of conductive branches (direction taken properly into account). If no such conduction route is found, we cannot increase the input current any more than that corresponding to the given current configuration so long as we confine ourselves to the current configurations compatible with the given voltage configuration. For, if, otherwise, there were another compatible current configuration $'s^x$ for which $'s > s$, we should be able to find an incremental configuration Δs^x for which $\Delta s > 0$, which would mean the existence of at least one conduction route

for incremental current from the input to the output node (because of the continuity of Δs^* or (3.2.1') and (3.2.3')). If a conduction route exists, determine the maximum amount of incremental current which can be assigned along that route, add (i.e. superpose) that incremental current configuration to the given one, and write the resulting current configuration again by s^* . From the above considerations it is obvious that the new set of s^* 's is feasible and compatible with the given voltage configuration. We repeat this process until no conduction route is found any more from the input node σ_1^0 to the output σ_m^0 or a conduction route is found along which the infinite amount of incremental current is admissible. The repetition will seldom fail to terminate after a finite number of steps. Speaking more precisely, to secure the finiteness of the number of steps required in a current-increasing step, we must proceed with the following additional condition:

Once a branch has been brought into state B or D from another state (i.e. from C or D resp. B or C), that branch should be regarded as open-circuited until we come to the situation that no conduction route not including that branch can be found. When we encounter such a situation, we ignore whether or not a branch has been brought into state B or D before that instant, restarting anew. (Cf. also the proof of the finiteness of the number of necessary steps in §3.5.)

During a current-increasing step the states of branches change as follows.

$$\begin{array}{lll} A \longrightarrow A, & B \longrightarrow B, C \text{ or } D, & C \longrightarrow B, C \text{ or } D, \\ & D \longrightarrow B, C \text{ or } D, & E \longrightarrow E. \end{array}$$

All the current-configurations appearing in the course of a current-increasing step are compatible with the given voltage configuration, so that they are minimum-cost for the corresponding s . The increment of $f(s)$ corresponding to the incremental current Δs^* is determined from equation (3.1.1) (with the inequality replaced by an equality) as follows:

$$\Delta f = f(s + \Delta s) - f(s) = u \cdot \Delta s, \quad (3.2.5)$$

because u , c^* 's and E_e 's are fixed during a current-increasing step.

If we cannot find conduction route any more we proceed to a voltage-increasing step, and if the infinite incremental input current is admissible the solution process terminates.

3.3. Voltage-increasing step or $\langle V \rangle$. Let us now suppose a compatible pair of current and voltage configurations is given, and try to increase the voltage $u(=u_1)$ at the input node with the current configuration fixed, requiring only such voltage configurations as are compatible with the given current configuration to appear. If we denote the given currents and voltages by

$$s, s^e, u_a(u_1=u, u_m=0), E_\kappa, E'_\kappa, \text{ etc.,}$$

respectively, the conditions for another voltage configuration $'u_a$ ($'u_1='u, 'u_m=0$), $'E_\kappa, 'E'_\kappa$ to be feasible and compatible with the given current configuration are written as follows:

$$\left. \begin{aligned} &'E_\kappa \geq 0, 'E'_\kappa \geq 0, 'E_\kappa \cdot 'E'_\kappa = 0, \\ &e_\kappa = \sum_{\alpha=1}^m [\sigma_\kappa^\alpha : \sigma_\alpha^0] 'u_\alpha - ('E_\kappa - 'E'_\kappa), \end{aligned} \right\} \quad (3.3.1)$$

$$\left. \begin{aligned} &'E_\kappa = 0 \quad \text{if} \quad s^e < c^e, \\ &'E'_\kappa = 0 \quad \text{if} \quad s^e > 0. \end{aligned} \right\} \quad (3.3.2)$$

The θ -matrix method to be explained just below is a device for determining a voltage configuration which, satisfying (3.3.1) and (3.3.2), gives the maximum $u(=u_1)$.

First define θ_κ and θ'_κ by (3.3.3):

$$\theta_\kappa = \begin{cases} -e_\kappa & \text{if branch } \kappa \text{ is in state A, B or C} \\ & \text{with respect to the given current} \\ & \text{and voltage configurations,} \\ \infty & \text{if branch } \kappa \text{ is in state D or E,} \end{cases}$$

$$\theta'_\kappa = \begin{cases} \infty & \text{if branch } \kappa \text{ is in state A or B,} \\ e_\kappa & \text{if branch } \kappa \text{ is in state C, D or E.} \end{cases} \quad (3.3.3)$$

state of branch	A or B	C	D or E

Putting

$$\left. \begin{aligned} \mathcal{J}_\kappa(0) &= \infty, \\ \mathcal{J}_\kappa(1) &= \theta_\kappa, \\ \mathcal{J}_\kappa(-1) &= \theta'_\kappa, \end{aligned} \right\} \quad (3.34)$$

define the matrix Θ as follows:

$$\Theta = (\theta_b^a): \quad \theta_b^a = \begin{cases} 0 & \text{for } a=b, \\ \min_{\kappa} [\mathcal{J}_\kappa((-[\sigma_\kappa^1: \sigma_b^0]) | [\sigma_\kappa^1: \sigma_a^0] |)] & \text{for } a \neq b, \end{cases} \quad (3.35)$$

($a, b=1, 2, \dots, m; \quad \kappa=1, 2, \dots, n$).

In brief, θ_b^a is the minimum of θ_κ 's of the branches connecting node a to node b and of θ'_κ 's of the branches connecting node b to a , and equal to ∞ if there is no such branch.

Here we define a multiplication of a Θ -matrix by another Θ -matrix and of a vector by a Θ -matrix:

$$\left. \begin{aligned} \Theta * v &= (\theta_b^a) * (v_a) = (\min_a (\theta_b^a + v_a)), \\ \Theta * \Theta' &= (\theta_b^c) * (\theta'_c{}^a) = (\min_c (\theta_b^c + \theta'_c{}^a)). \end{aligned} \right\} \quad (3.36)$$

Note the similarity of this multiplication rule to the ordinary multiplication rule for matrices and vectors:

$$Ax = (a_i^j)(x_j) = (\sum_j (a_i^j \times x_j)), \quad AB = (a_i^k)(b_k^j) = (\sum_k (a_i^k \times b_k^j)).$$

It is readily seen that

$$\left. \begin{aligned} \Theta * (\Theta' * v) &= (\Theta * \Theta') * v, \\ \Theta * (\Theta' * \Theta'') &= (\Theta * \Theta') * \Theta'' \quad \left(\stackrel{\text{def.}}{=} \Theta * \Theta' * \Theta'' \right), \\ \Theta * \Theta * \dots * \Theta &= \left[\min_{c_1, c_2, \dots, c_{N-1}} \left(\theta_b^{c_1} + \theta_{c_1}^{c_2} + \dots + \theta_{c_{N-2}}^{c_{N-1}} + \theta_{c_{N-1}}^a \right) \right]. \end{aligned} \right\} \quad (3.37)$$

Next, put

$$v = (v_a): \quad \begin{cases} v_a = \infty & (a=1, 2, \dots, m-1), \\ v_m = 0, \end{cases} \quad (3.38)$$

and calculate iteratively

$$v^{i+1} = \Theta^i v \quad (i=0, 1, 2, \dots). \quad (3.39)$$

Then it follows at once from (3.35) that

$$v_b^{i+1} = \min_a (\theta_b^a + v_a^i) \leq \theta_b^b + v_b^i = v_b^i,$$

so that we have the non-increasing sequence

$$\overset{0}{\mathbf{v}} \geq \overset{1}{\mathbf{v}} \geq \overset{2}{\mathbf{v}} \geq \dots \dots \dots \quad (3.3.10)$$

of \mathbf{v}' 's, where $\mathbf{v} \geq \mathbf{v}'$ means $v_a \geq v'_a$ for all a . The sequence (3.3.10) rapidly converges, i.e. we have for some $N(\leq m-1)$

$$\overset{0}{\mathbf{v}} > \overset{1}{\mathbf{v}} > \overset{2}{\mathbf{v}} > \dots > \overset{N}{\mathbf{v}} = \overset{N+1}{\mathbf{v}} = \overset{N+2}{\mathbf{v}} = \dots = \overset{\text{def. } \infty}{\mathbf{v}}, \quad (3.3.11)$$

where $\mathbf{v} > \mathbf{v}'$ means that $v_a \geq v'_a$ for all a and $v_a > v'_a$ for at least one a , which is proved as follows.

It is obvious that, if $\overset{N}{\mathbf{v}} = \mathbf{v}$, then $\overset{N'}{\mathbf{v}} = \mathbf{v}$ for all $N' \geq N$. By definition

$$\overset{m}{\mathbf{v}} = (\overset{m}{v_b}) = \underbrace{\Theta^* \dots \Theta^*}_{m} \overset{0}{\mathbf{v}} = \left[\min_{c_1, \dots, c_{m-1}} (\theta_b^{c_1} + \theta_{c_1}^{c_2} + \dots + \theta_{c_{m-2}}^{c_{m-1}} + \theta_{c_{m-1}}^m) \right]. \quad (3.3.12)$$

Since the number of nodes is m , for each sum of θ 's in the parentheses at least two of the $m+1$ nodes $\sigma_b^0, \sigma_{c_1}^0, \sigma_{c_2}^0, \dots, \sigma_{c_{m-2}}^0, \sigma_{c_{m-1}}^0, \sigma_m^0$ must coincide with each other. Let them be $\sigma_{c_i}^0$ and $\sigma_{c_j}^0$ ($i < j$; $\sigma_{c_i}^0$ may be σ_b^0 and $\sigma_{c_j}^0$ may be σ_m^0). Then we have, for every choice of $\sigma_{c_1}^0, \dots, \sigma_{c_{m-1}}^0$,

$$\begin{aligned} & \theta_b^{c_1} + \theta_{c_1}^{c_2} + \theta_{c_2}^{c_3} + \dots + \theta_{c_{m-2}}^{c_{m-1}} + \theta_{c_{m-1}}^m \\ &= (\theta_b^{c_1} + \theta_{c_1}^{c_2} + \dots + \theta_{c_{i-1}}^{c_i (=c_j)} + \theta_{c_j (=c_i)}^{c_{j+1}} + \dots + \theta_{c_{m-2}}^{c_{m-1}} + \theta_{c_{m-1}}^m) \\ & \quad + (\theta_{c_i (=c_j)}^{c_{i+1}} + \theta_{c_{i+1}}^{c_{i+2}} + \dots + \theta_{c_{j-2}}^{c_{j-1}} + \theta_{c_{j-1}}^{c_i}), \end{aligned}$$

and, as the consequence of the following Lemma,

$$\begin{aligned} & \theta_b^{c_1} + \theta_{c_1}^{c_2} + \dots + \theta_{c_{m-2}}^{c_{m-1}} + \theta_{c_{m-1}}^m \\ & \geq \theta_b^{c_1} + \theta_{c_1}^{c_2} + \dots + \theta_{c_{i-1}}^{c_i (=c_j)} + \theta_{c_j (=c_i)}^{c_{j+1}} + \dots + \theta_{c_{m-2}}^{c_{m-1}} + \theta_{c_{m-1}}^m \geq^{m-(j-i)} v_b. \end{aligned}$$

Hence, for each b , we have

$$v_b = \min_{c_1, \dots, c_{m-1}} (\theta_b^{c_1} + \theta_{c_1}^{c_2} + \dots + \theta_{c_{m-2}}^{c_{m-1}} + \theta_{c_{m-1}}^m) \geq \min_{j > i}^{m-(j-i)} v_b.$$

Finally, it follows from (3.3.10) that

$$v_b \geq \min_{j > i}^{m-(j-i)} v_b = v_b^{m-1} \quad \text{and} \quad v_b^{m-1} \geq v_b^m.$$

Therefore, for each b ,

$$v_b^{m-1} = v_b^m \quad \text{or} \quad v_b^{m-1} = v_b^m. \quad (3.3.13)$$

Lemma. The sum of the form $\theta_{c_1}^{c_2} + \theta_{c_2}^{c_3} + \dots + \theta_{c_{N-2}}^{c_{N-1}} + \theta_{c_{N-1}}^N$, where $c_1 = c_N$ and $\theta_{c_i}^{c_{i+1}}$'s are defined with respect to a compatible pair of current and voltage configurations, is always non-negative.

Proof: The lemma is obvious for $N=2$ by definition. Therefore let us consider the case $N \geq 3$. Moreover, if one of $\theta_{c_i}^{c_{i+1}}$'s is ∞ , the sum is also equal to ∞ , and, consequently, the lemma holds. Hence we may confine ourselves to the case where all $\theta_{c_i}^{c_{i+1}} < \infty$. In such a case, $\theta_{c_i}^{c_{i+1}}$ is equal to θ_κ or θ'_κ of some branch κ whose boundary nodes are $\sigma_{c_i}^0$ and $\sigma_{c_{i+1}}^0$, or, to 0 if $c_i = c_{i+1}$. Hence every sum of the above form is equal to the sum of a sequence of θ_κ 's and θ'_κ 's such that the corresponding sequence of branches constitute a loop, i.e. that every branch in the sequence has one of its boundary nodes in common with the branch preceding it and the other with the branch following it, and, in addition, the first branch and the last have a node (not belonging to the set of nodes mentioned just above) in common. Thus it suffices to prove that the sum of θ_κ 's and θ'_κ 's along a loop is always non-negative if θ_κ 's and θ'_κ 's are defined with respect to a compatible pair of current and voltage configurations.

Let us denote the given currents and voltages by s^κ , u_κ , E_κ and E'_κ , respectively, and consider a loop (its direction is taken account of). The sum in question is the sum of θ_κ 's of the branches which are contained in the loop with negative sign (i.e. whose orientation is opposite to the direction of the loop) and of θ'_κ 's of those which are contained in the loop with positive sign (i.e. whose orientation is the same as the direction of the loop). If one of these θ_κ 's and θ'_κ 's is ∞ , the sum is also ∞ (because $-\infty < \theta_\kappa$, $\theta'_\kappa \leq \infty$), and hence non-negative. Therefore, we may consider only the case where all the θ_κ 's and θ'_κ 's appearing in the sum are finite in value. Definition (3.3.3) tells us that, in such a case,

for a branch contained in the loop with negative sign

$$\theta_\kappa = -e_\kappa \text{ and the state is A, B or C,}$$

and

for a branch contained in the loop with positive sign

$$\theta'_\kappa = e_\kappa \text{ and the state is C, D or E.}$$

Let the sequence of branches contained in the loop be $\sigma_{\kappa_1}^1, \dots, \sigma_{\kappa_N}^1$ (some of them may coincide) and that of nodes be $\sigma_{a_0}^0, \dots, \sigma_{a_{N-1}}^0$ ($\sigma_{a_N}^0 = \sigma_{a_0}^0$), where

$$\left. \begin{aligned}
 & [\sigma_{\kappa_i}^1 : \sigma_{a_{i-1}}^0] = 1, \quad [\sigma_{\kappa_i}^1 : \sigma_{a_i}^0] = -1 \\
 & \text{when branch } \sigma_{\kappa_i}^1 \text{ is contained in the loop} \\
 & \text{with positive sign,} \\
 \text{and} \\
 & [\sigma_{\kappa_i}^1 : \sigma_{a_{i-1}}^0] = -1, \quad [\sigma_{\kappa_i}^1 : \sigma_{a_i}^0] = 1 \\
 & \text{when branch } \sigma_{\kappa_i}^1 \text{ is contained in the loop} \\
 & \text{with negative sign,}
 \end{aligned} \right\} (3.314)$$

Then the following relation holds for the given voltages because of the feasibility (D2). (We define $\infty - \infty = 0$ for the time being.)

$$\left. \begin{aligned}
 \theta_{\kappa_i} &= -e_{\kappa_i} = u_{a_{i-1}} - u_{a_i} + E_{\kappa_i} - E'_{\kappa_i} \\
 & \text{for the branches contained in the loop} \\
 & \text{with negative sign,} \\
 \theta'_{\kappa_i} &= e_{\kappa_i} = u_{a_{i-1}} - u_{a_i} - E_{\kappa_i} + E'_{\kappa_i} \\
 & \text{for the branches contained in the loop} \\
 & \text{with positive sign.}
 \end{aligned} \right\} (3.315)$$

Moreover, since the given configurations are compatible, by virtue of the optimality condition we have

$$E_{\kappa} - E'_{\kappa} \geq 0 \quad \text{for the former branches,}$$

and

$$-E_{\kappa} + E'_{\kappa} \geq 0 \quad \text{for the latter branches.}$$

Summing up the above θ_{κ_i} or θ'_{κ_i} for $i=1, 2, \dots, N$ we have

$$\sum_{i=1}^N (\theta_{\kappa_i} \text{ or } \theta'_{\kappa_i}) \geq \sum_{i=1}^N u_{a_{i-1}} - \sum_{i=1}^N u_{a_i} = 0, \quad (3.316)$$

because $u_{a_N} = u_{a_0}$. This completes the proof.

Now we define a new voltage configuration by

$$'u = \overset{\infty}{v} \quad \text{or} \quad 'u_a = \overset{\infty}{v}_a \quad ('u = 'u_1, 'u_m = 0)$$

and

$$'E_{\kappa} - 'E'_{\kappa} = \sum_{a=1}^m [\sigma_{\kappa}^1 : \sigma_a^0] 'u_a - e_{\kappa} \quad ('E_{\kappa}, 'E'_{\kappa} \geq 0, 'E_{\kappa} \cdot 'E'_{\kappa} = 0). \quad (3.317)$$

Regarding the new voltage configuration thus obtained we have the following two theorems.

Theorem 1. The new voltage configuration is compatible with the given current configuration.

Proof: From (3.3.9) and (3.3.11) it follows that

$$\left. \begin{aligned} \theta_{c_{i-1}}^{c_i} &= \theta_{\kappa} \text{ for a branch } \sigma_{\kappa}^1 \text{ contained in the path} \\ &\text{with negative sign,} \\ \theta_{c_{i-1}}^{c_i} &= \theta'_{\kappa} \text{ for a branch } \sigma_{\kappa}^1 \text{ contained in the path} \\ &\text{with positive sign,} \end{aligned} \right\} \quad (3.3.22)$$

($i=1, 2, \dots, N$; $c_0=a, c_N=m$). (See (3.3.12) and cf. also the proof to the previous Lemma.)

If $'u_a = \infty$, the theorem is obvious. Therefore it suffices to consider only the case where all the θ_{κ} and θ'_{κ} appearing in the sum (3.3.21) are finite in value. At the nodes along this path

$$'u_{c_i} = \theta_{c_i}^{c_{i+1}} + \dots + \theta_{c_{N-2}}^{c_{N-1}} + \theta_{c_{N-1}}^m \quad (3.3.23)$$

for, if $'u_{c_i} \leq \theta_{c_i}^{c_{i+1}} + \dots + \theta_{c_{N-1}}^m$, it would contradict

$$\min_a (\theta_a^b + 'u_a) = 'u_b.$$

Then, from (3.3.22) and (3.3.3) it follows that

$$\left. \begin{aligned} &\text{if branch } \sigma_{\kappa}^1 \text{ is contained in the path with negative sign,} \\ &\quad \kappa^{c_i} > 0 \text{ and } \theta_{\kappa} = -e_{\kappa} = 'u_{c_i} - 'u_{c_{i-1}} \\ \text{and} \\ &\text{if branch } \sigma_{\kappa}^1 \text{ is contained in the path with positive sign,} \\ &\quad \kappa^{c_i} < c^{c_i} \text{ and } \theta'_{\kappa} = e_{\kappa} = 'u_{c_i} - 'u_{c_{i-1}}. \end{aligned} \right\} \quad (3.3.24)$$

Hence

$$'u_a = \sum_{i=1}^N \varepsilon_i e_{\kappa_i} \quad ('u_m = 0), \quad (3.3.25)$$

where ε_i is +1 or -1 according as branch σ_{κ}^1 is contained in the path with positive or negative sign.

On the other hand, for any voltage configuration ($''u_b, ''E_{\kappa}, ''E'_{\kappa}$) that is compatible with the given current configuration, we have

$$''u_{c_i} - ''u_{c_{i-1}} = \varepsilon_i (e_{\kappa_i} + ''E_{\kappa_i} - ''E'_{\kappa_i}), \quad (3.3.26)$$

whence follows

$$''u_a = \sum_{i=1}^N \varepsilon_i e_{\kappa_i} + \sum_{i=1}^N \varepsilon_i (''E_{\kappa_i} - ''E'_{\kappa_i}) = 'u_a + \sum_{i=1}^N \varepsilon_i (''E_{\kappa_i} - ''E'_{\kappa_i}). \quad (3.3.27)$$

Since

$$\left. \begin{aligned} ''E_{\kappa_i} - ''E'_{\kappa_i} &\geq 0 & \text{if } \varepsilon_i = -1, \\ ''E_{\kappa_i} - ''E'_{\kappa_i} &\leq 0 & \text{if } \varepsilon_i = +1 \end{aligned} \right\} \quad (3.3.28)$$

$$\Theta^* \mathbf{u} = \mathbf{u} \text{ or } \min_a (\theta_a^0 + u_a) = u_b, \text{ hence } u_b - u_a \leq \theta_b^0. \quad (3.3.18)$$

This, combined with (3.3.4), (3.3.5) and (3.3.17), gives the inequalities for each κ

$$\left. \begin{aligned} \theta'_\kappa &= \mathcal{D}_\kappa(-1) \geq \theta_a^0 \geq u_a - u_b, \\ u_a - u_b &= e_\kappa + E'_\kappa - E'_\kappa, \\ -\theta_\kappa &= -\mathcal{D}_\kappa(1) \leq -\theta_b^0 \leq u_a - u_b, \end{aligned} \right\} \quad (3.3.19)$$

where we assume that $[\sigma_\kappa^1 : \sigma_a^0] = 1$ and $[\sigma_\kappa^1 : \sigma_b^0] = -1$. Thus we have

$$\theta'_\kappa - e_\kappa \geq E'_\kappa - E'_\kappa \geq -(\theta_\kappa + e_\kappa). \quad (3.3.20)$$

(3.3.20), together with (3.3.3), states that

$$E'_\kappa - E'_\kappa \geq 0, \text{ hence } E'_\kappa = 0,$$

if branch κ was in state A, B or C in regard to the old voltage configuration, i.e. if $s^\kappa > 0$,

and

$$E'_\kappa - E'_\kappa \leq 0, \text{ hence } E'_\kappa = 0,$$

if branch κ was in state C, D or E, in regard to the old voltage configuration, i.e. if $s^\kappa < c^\kappa$,

which is no other than the desired optimality condition (3.3.2).

Theorem 2. The new u_a at node σ_a^0 , hence the \mathbf{u} in particular, thus obtained is not less than the u_a of any other voltage configuration compatible with the given current configuration.

Proof: By a path of length N from node σ_a^0 to node σ_b^0 we mean a sequence of $N+1$ nodes and N branches

$$\{\sigma_a^0 = \sigma_{c_0}^0, \sigma_{\kappa_1}^1, \sigma_{c_1}^0, \sigma_{\kappa_2}^1, \sigma_{c_2}^0, \dots, \sigma_{c_{N-1}}^0, \sigma_{\kappa_N}^1, \sigma_{c_N}^0 = \sigma_b^0\}$$

such that $\sigma_{c_{i-1}}^0$ and $\sigma_{c_i}^0$ are the boundary nodes of $\sigma_{\kappa_i}^1$. When $[\sigma_{\kappa_i}^1 : \sigma_{c_{i-1}}^0] = 1(-1)$ and $[\sigma_{\kappa_i}^1 : \sigma_{c_i}^0] = -1(1)$, branch $\sigma_{\kappa_i}^1$ is said to be contained in the path with positive (negative) sign. (In case $\sigma_a^0 = \sigma_b^0$ we have a loop as was already mentioned in the above.) Then, for each node σ_a^0 , there exists a path of length N from node σ_a^0 to node σ_m^0 such that

$$u_a = \theta_a^{c_1} + \theta_{c_1}^{c_2} + \dots + \theta_{c_{N-2}}^{c_{N-1}} + \theta_{c_{N-1}}^m \quad (3.3.21)$$

because $u_a = v_a = (\Theta^N \mathbf{v})_a$ for a certain N , where

by virtue of (3.3.24) and the optimality condition, we are led to the conclusion that

$$''u_a \leq 'u_a. \tag{3.3.29}$$

Thus the theorem is proved.

We have presented a method to determine a voltage configuration which, being compatible with the given current configuration, gives the highest possible $'u$.

If $'u = \infty$, the solution process terminates, because, as will later be shown, s cannot increase any more.

If $'u < \infty$, we proceed to a current-increasing step.

Obviously no change will occur in $f \left(= \sum_{\kappa=1}^n e_{\kappa} s^{\kappa} \right)$ through a voltage-increasing step, so that no change will occur in $g \left(= su - \sum_{\kappa=1}^n c^{\kappa} E_{\kappa} \right)$ since

$$'g = s'u - \sum_{\kappa=1}^n c^{\kappa} 'E_{\kappa} = f(s) = su - \sum_{\kappa=1}^n c^{\kappa} E_{\kappa} = g, \tag{3.3.30}$$

both the old and the new voltage configuration being compatible with a fixed—i.e. the given—current configuration.

In case $'u = \infty$, we may recalculate $'u_a$'s by replacing all the elements of Θ which are ∞ by a symbol M (assumed to be finite but large enough) to assert (3.3.30). Then (3.3.30) holds for any M sufficiently large. But such is only for theoretical interest, not necessary in practice.

3.4. Theorems concerning the details of the solution process. In

order to show that the repeated application of the two kinds of steps explained above generates a complete solution for the problem, we shall prove the theorems fundamental in the theory of transportation networks.

Theorem 1. } (already proved in the previous section with the
Theorem 2. } explanation of their significance)

By virtue of (3.2.5) and (3.3.30), it is sufficient to consider the $s \sim u$ relation instead of the $s \sim f(s)$ relation.

Theorem 3. Let $(s_1^{\kappa}; u_a, E_2^{\kappa}, E_2^{\prime \kappa})$ and $(s_2^{\kappa}; u_a, E_2^{\kappa}, E_2^{\prime \kappa})$ be two compatible pairs of current and voltage configurations, and (λ, μ) be an arbitrary pair of non-negative real numbers such that $\lambda + \mu = 1$. If $s_1^{\kappa} = s_2^{\kappa}$, then the voltage configuration defined by

$$\left. \begin{aligned} u_a &= \lambda u_a + \mu u_a, \\ E_k &= \lambda E_k + \mu E_k, \\ E'_k &= \lambda E'_k + \mu E'_k \end{aligned} \right\} \quad (3.4.1)$$

is also compatible with the current configuration $s^r (= s^r)$. If $u_a = u_a$ (hence $E_k = E_k$ and $E'_k = E'_k$), then the current configuration defined by

$$s^r = \lambda s^r + \mu s^r \quad (3.4.2)$$

is also compatible with the voltage configuration.

Proof: The theorem is obvious because all the equalities and inequalities in the feasibility and the optimality conditions are linear in primal variables as well as in dual variables.

Theorem 4 states that s and u are certainly increased through a current- and a voltage-increasing step.

Theorem 4. If a current-increasing step has finished with a finite s , in the next voltage-increasing step u can certainly be increased. If a voltage-increasing step has finished with a finite u , in the next current-increasing step s can certainly be increased.

Proof of the first half: It readily follows from Theorem 2 that the ' u ' ($= u_1$) determined by the Θ -matrix method after a current-increasing step has finished is greater than or equal to the previous u ($= u_1$). If ' $u = \infty$ ', then ' $u > u$ ', and hence the first half of the theorem holds since $u < \infty$ by the assumption of the theorem. So let us suppose ' $u = u$ ' ($< \infty$). As in the proof given to Theorem 2 we can find a path $\{\sigma_1^0, \sigma_{\kappa_1}^1, \sigma_{c_1}^0, \dots, \sigma_{c_{N-1}}^0, \sigma_{\kappa_N}^1, \sigma_m^0\}$ from the input node σ_1^0 to the output σ_m^0 such that

$$\left. \begin{aligned} 'u (= u_1) &= \theta_{c_1}^{c_1} + \theta_{c_1}^{c_2} + \dots + \theta_{c_{N-2}}^{c_{N-1}} + \theta_{c_{N-1}}^m \\ \theta_{c_{i-1}}^{c_i} &= \theta'_{\kappa_i} \text{ or } \theta_{\kappa_i} \text{ according as} \\ &[\sigma_{\kappa_i}^1 : \sigma_{c_{i-1}}^0] = 1 \quad ([\sigma_{\kappa_i}^1 : \sigma_{c_{i-1}}^0] = -1) \\ &\text{or } [\sigma_{\kappa_i}^1 : \sigma_{c_i}^0] = -1 \quad ([\sigma_{\kappa_i}^1 : \sigma_{c_i}^0] = 1), \end{aligned} \right\} \quad (3.4.3)$$

and

$$'u_{c_i} = \theta_{c_i}^{c_{i+1}} + \dots + \theta_{c_{N-2}}^{c_{N-1}} + \theta_{c_{N-1}}^m$$

It then follows that, along this path,

$$'u_{c_i} = u_{c_i} \quad \text{for all } i, \quad (3.4.4)$$

where u_a 's denote the previous voltages, for if

$$'u_{c_i} > u_{c_i}$$

at some c_i ($'u_{c_i} < u_{c_i}$ is excluded by Theorem 2) we should have

$$\begin{aligned} 'u(= 'u_1) &= \theta_1^{c_1} + \theta_{c_1}^{c_2} + \dots + \theta_{c_{N-2}}^{c_{N-1}} + \theta_{c_{N-1}}^m \\ &= \theta_1^{c_1} + \dots + \theta_{c_{i-1}}^{c_i} + 'u_{c_i} \\ &> \theta_1^{c_1} + \dots + \theta_{c_{i-1}}^{c_i} + u_{c_i} \geq \min_{c_1, \dots, c_{i-1}} (\theta_1^{c_1} + \dots + \theta_{c_{i-1}}^{c_i}) + u_{c_i} \\ &\geq u(= u_1), \end{aligned} \quad (3.4.5)$$

which contradicts the assumption that $'u = u$.

Hence, under the assumption that $'u = u$, the branches along the path should have been in the same state before the step as they are now. Since $u_{c_i} - u_{c_{i-1}} = \theta_{c_{i-1}}^{c_i} = \theta_{\kappa_i}$ or $\theta'_{\kappa_i} = \pm e_{\kappa_i}$ in such a case, a branch contained in the path with positive sign is, and was, in state C or D and a branch contained in the path with negative sign is, and was, in state B or C, which, however, means that a conduction route from the input to the output node existed even with regard to the previous voltages, contradicting the assumption of the theorem that a current-increasing step has finished. Thus we completed the proof of $'u > u$ by reductio ad absurdum of $'u = u$.

Proof of the second half: Let us consider the path of the form (3.4.3). Such a path exists because of the assumption that $'u$ ($= 'u_1$) is finite. Similar considerations to those in the above proof of the first half lead to the conclusion that the path now considered is a conduction route from σ_1^0 to σ_m^0 for incremental current.

That the $s \sim u$ relation thus obtained is unique follows from Theorem 3 and Theorem 5 (the converse of Theorem 4) just to follow.

Theorem 5. Given a compatible pair of current and voltage configurations, then, with the current configuration fixed, the voltage configuration can be so varied that u may increase (decrease) only when s is the maximum (minimum) possible for the given voltage configuration; or, equivalently,⁴⁾ with the voltage con-

4) The contrapositive proposition to the above.

figuration fixed, s can be increased (decreased) only when u is the maximum (minimum) possible for the given current configuration.

From Theorem 5 it is seen that we can completely determine the $s \sim u$ relation by the repeated application of voltage- and current-increasing steps, there remaining to be proved only the finiteness of the number of necessary steps or substeps.

Proof to Theorem 5: If we perform a voltage-increasing step under the circumstances where s can be increased with the given voltages, we obtain the maximum possible $'u$ compatible with the given current configuration (see Theorem 2). In the same way as in the proof of Theorem 4, we can find a conduction route from σ_1^0 (input) to σ_m^0 (output) for incremental current with regard to the new voltage configuration. Let us then increase s by sufficiently small amount δ along the route. Then the increase in the total cost is, by (3.2.5),

$$f(s+\delta) - f(s) = 'u\delta \tag{3.4.6}$$

on the one hand. But, on the other, s can be increased with regard also to the old voltage configuration, so that we have

$$f(s+\delta) - f(s) = u\delta. \tag{3.4.7}$$

Since $f(s)$ should be a single-valued function of s by definition, we have

$$'u = u. \tag{3.4.8}$$

Therefore u cannot be increased under these circumstances.

The remaining part of the theorem is obvious from the above proof, as it is converted into the above-proved part by replacing the rôles of the input and the output node.

That it is an easy task to find a conduction route from the input to the output node for incremental current is guaranteed by the following theorem.

Theorem 6. With regard to a voltage configuration determined by means of a voltage-increasing step, if u_a is finite there exists at least one conduction route from node σ_a^0 to the output node σ_m^0 ; and furthermore, if u_a is finite there exists a branch in state C or D (B or C) connecting σ_a^0 to another node σ_b^0 (another node σ_b^0 to σ_a^0) with a finite u_b , i.e. there exists a

conduction route (of length 1) from σ_a^0 to another node, say σ_b^0 , from which a conduction route to the output node can again be found.

Proof: The first half may be proved in a way analogous to Theorem 2 or 4. The second half is obvious from the second equation of (3.3.18) and the definition of Θ (3.3.3)~(3.3.5).

We have also the theorems concerning the uniqueness of current and voltage configurations, but we shall omit them. See [13] and [14].

3.5. Proof of the finiteness of the number of necessary steps in the solution process. As has so far been explained, current-increasing and voltage-increasing steps are used alternately to solve a transportation-network problem. Therefore, in order to prove the finiteness of the total number of necessary steps included in the whole solution process, we first show the finiteness of the number of voltage-increasing steps (which is equal to, or is different by one from, the number of current-increasing steps because they are used one after the other) included, and then the finiteness of the number of substeps included in each current-increasing, as well as voltage-increasing, step.

(i) The number of voltage-increasing steps is finite:— u increases monotonously as the solution process proceeds. Furthermore, each value of u is either equal to the sum of $\pm e_i$'s along a path from the input to the output node, which does not contain a loop consisting of a subset of the branches belonging to it, or to infinity. (The fact often used in the proofs of the theorems in the previous section. The condition for the exclusion of a loop follows from Lemma in §3.3.) Since the number of paths from a specified node to another in a network which contain no loop is obviously finite, the number of possible values of u is also finite. Hence, the number of voltage-increasing steps must be finite.

(ii) The number of current-increasing steps is finite:—This follows at once from the above (i).

(iii) The number of substeps included in a voltage-increasing step is finite:—As was explained in §3.3, in order to determine a voltage configuration it suffices to define the matrix Θ and then to multiply Θ by a vector at most $m-1$ times, which calculation obviously consists of a finite number of iterative steps.

(iv) The number of substeps included in a current-increasing step

is finite [12] :—A current-increasing step consists essentially in finding a maximum amount of incremental input-output current through a specified set of branches, of which each is endowed with capacity restrictions in the respective directions (cf. (3.2.1') and (3.2.2')). Let us consider an n -dimensional space whose points represent incremental current configurations with coordinates $\Delta s^e = (\Delta s^1, \dots, \Delta s^n)$. Those points which represent feasible configurations are restricted within a linear subspace by (3.2.2') and the second equation of (3.2.1'), and furthermore, within a convex region (bounded or unbounded) by the first equation of (3.2.1'). Here it should be noted that the convex region thus defined has only a finite number of boundary hyperplanes as well as a finite number of boundary spaces (or faces) of lower dimensions. On the whole convex region, a linear function Δs of Δs^e 's is defined by (3.2.3'). Searching for a conduction route from the input node σ_1^0 to the output σ_m^0 corresponds to searching for a direction (from the point representing the starting current configuration, i.e. $\Delta s^e = 0$) in which Δs increases, and assigning the maximum amount of incremental current along the route corresponds to going straight in that direction until we reach a point of a certain face of the convex region. We then search for another conduction route not containing a branch brought into state B or D, which corresponds to searching for a direction, confined within the face thus reached, in which Δs increases. In this way, the dimension of the face within which a Δs -increasing direction is searched for monotonously decreases, until we finally come to a situation that no Δs -increasing direction can be found so long as we confine ourselves within the face thus reached. (We shall tentatively call such a face as this a "maximal face". The case where the maximal face is a vertex of the convex region is also included.) Then, we again begin to search for a conduction route disregarding whether a branch has ever been brought into state B or D, which corresponds to searching for a Δs -increasing direction freely in the whole convex region. The procedure to follow is the same as explained just above.

Since the dimension of the convex region is finite, after a finite number of steps we either reach a maximal face or find a Δs -increasing direction in which the convex region is not bounded. In the latter case, Δs can also be increased infinitely, and the solution process terminates.

Moreover, since the number of faces is finite and the same face never appears more than once as the maximal face (because Δs steadily increases as the process proceeds), the infinite sequence of maximal faces cannot arise. Therefore, after a finite number of steps, we either reach a point (i.e. we obtain a current configuration) from which no Δs -increasing direction can be found (i.e. no conduction route can be found), or find a Δs -increasing direction in which the convex region is not bounded.

Thus we have proved that the total number of steps necessary for solving a general transportation-network problem is always finite.

It should be noted here that the finiteness of the number of necessary steps depends essentially on the finite topological structure of the transportation network as well as that of the convex region representing incremental current configurations (the latter again depending on the former in substance), and not on the integrity or rationality of the numbers we employ in calculation (cf. [7], [8], [9]).

4. ADDITIONAL NOTES

4.1. Shortest-route problem. This extremely simple problem has often been treated by various authors [18], [19], [20] in various ways,† but it seems that our voltage-increasing step affords, when applied to this problem, a simplest method. For example, consider a system of m places mutually connected by n routes, for each of which something like distance is defined. Put

$$\left. \begin{aligned} \theta_x &= \text{the distance of the route, represented by} \\ &\quad \text{branch } \sigma_x^1, \text{ in the same direction as the} \\ &\quad \text{orientation of the branch,} \\ \theta'_x &= \text{the distance of the route, represented by} \\ &\quad \text{branch } \sigma_x^1, \text{ in the direction opposite to the} \\ &\quad \text{orientation of the branch,} \end{aligned} \right\} \quad (4.1.1)$$

(where θ'_x may not necessarily be equal to θ_x), and define $\Theta = (\theta_x^a)$ by (3.3.4) and (3.3.5). If we want to obtain the shortest routes from the place represented by node σ_m^0 , then put

† Cf. also the review by M. Pollack and W. Wiebenson recently published in the *Journal of the O. R. Society of America* (Vol. 8, No. 2, 1960, pp. 224~230):—added in proof.

$$\overset{0}{v} = (\overset{0}{v}_a) : \overset{0}{v}_a = \infty \quad (a=1, 2, \dots, m-1), \overset{0}{v}_m = 0, \quad (4.1.2)$$

and calculate iteratively

$$\overset{i+1}{v} = \Theta * \overset{i}{v} \quad (i=0, 1, 2, \dots) \quad (4.1.3)$$

(see (3.3.6)). For an $N < m$ we have.

$$\overset{N+1}{v} = \overset{N}{v}. \quad (4.1.4)$$

Then put

$$\overset{N}{u} = \overset{N}{v} \quad \text{or} \quad u_a = v_a \quad (a=1, 2, \dots, m), \quad (4.1.5)$$

and add a special mark to the branches (direction taken into account) for which

$$u_b - u_a = \theta_b^a = \theta_c \quad \text{or} \quad \theta'_c. \quad (4.1.6)$$

The u_a 's denote the shortest distances from σ_m^0 to the respective places σ_a^0 's, and the shortest routes consist of the branches with the special mark, and of them only.

Example.⁵⁾ Find the shortest routes from a city called Los Angeles to the cities in Fig. 4.1.1, where the available routes and their distances (assumed to be independent of the direction) are shown by straight lines with numerals attached.

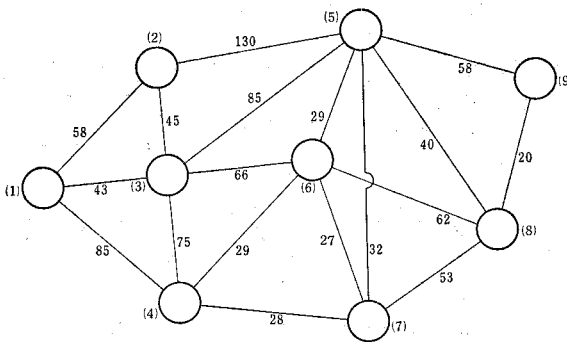

- | | | |
|--------------------|-----------------|----------------|
| (1) Los Angeles | (4) Dallas | (7) Memphis |
| (2) Portland | (5) Chicago | (8) Washington |
| (3) Salt Lake City | (6) Kansas City | (9) Boston |

Fig. 4.1.1

5) Slightly modified from the example of G. B. Dantzig [18]. The distances here employed are fictitious.

$a \backslash b$	1	2	3	4	5	6	7	8	9
1	0	58	43	85					
2	58	0	45		130				
3	43	45	0	75	85	66			
4	85		75	0		29	28		
5		130	85		0	29	32	40	58
6			66	29	29	0	27	62	
7				28	32	27	0	53	
8					40	62	53	0	20
9					58			20	0

(The blanks mean ∞ .)
(4.1.7)

$$\begin{aligned}
 \mathbf{v} &= (v_a^0) = [0 \quad \infty \quad \infty \quad \infty \quad \infty \quad \infty \quad \infty \quad \infty \quad \infty \quad \infty], \\
 \mathbf{v} &= (v_a^1) = [0 \quad 58 \quad 43 \quad 85 \quad 128 \quad 109 \quad 113 \quad 166 \quad 186], \\
 \mathbf{v} &= \mathbf{v} = \mathbf{u}.
 \end{aligned}
 \tag{4.1.8}$$

In the above calculation we resorted to the simplified algorithm explained in the following section §4.2, and the circles indicate the elements for which $u_b - u_a = \theta_b^a$. (Note that we interchanged the rôles of σ_1^0 and σ_m^0 in this calculation.)

Putting u_a 's at the respective places, and marking by bold lines with arrows the routes corresponding to the encircled elements, we have Fig. 4.1.2. Obviously (cf. Theorem 6 in §3.4), we can find a shortest

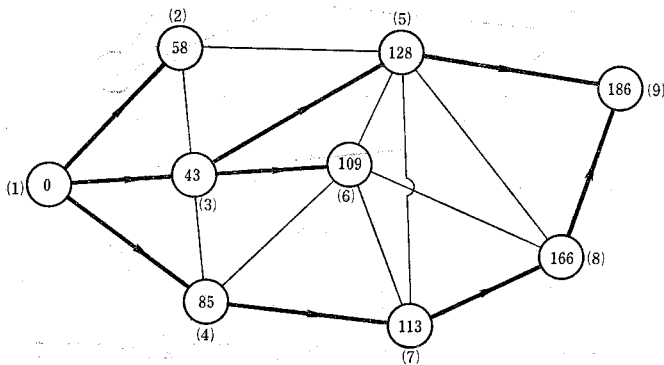

Fig. 4.1.2

route from Los Angeles to another city, say to Boston, by simply tracing backwards the bold-lined routes from Boston. Even if more than one bold-lined routes arrive at a city (e.g. at Boston), no serious problem occurs since we can always get to Los Angeles whichever route we may choose.

4.2. Two devices to simplify the calculation of voltages. The iteration formula

$$v = \Theta * v : v_b = \min_a (\theta_b^a + v_a) \tag{4.2.1}$$

may be modified to promote the speed of convergence as follows.

First renumber the nodes, i.e. permute the columns, and correspondingly the rows, of Θ in such a way that the resulting form of Θ has as many non-vanishing elements near its diagonal as possible with σ_m^0 fixed, and then calculate v_b 's from $b=m$ to $b=1$ by (4.2.2) :

$$v_b = \min \left\{ \min_{1 \leq a \leq b} (\theta_b^a + v_a), \min_{b < a \leq m} (\theta_b^a + v_a) \right\}. \tag{4.2.2}$$

u must be defined as $u_a (= v_a)$ for the input node (which may not be σ_1^0 after renumbering).

Moreover, it will be proved without difficulty that, as far as only conduction routes from σ_1^0 to σ_m^0 are concerned, we may use the voltages determined by

$$\left. \begin{aligned} & v_b = \min_{a \neq 1} (\theta_b^a + v_a) \\ \text{or} & v_b = \min \left\{ \min_{1 \leq a \leq b} (\theta_b^a + v_a), \min_{b < a \leq m} (\theta_b^a + v_a) \right\}, \end{aligned} \right\} \tag{4.2.3}$$

instead of (4.2.1) or (4.2.2). Although the voltage configurations thus obtained are not necessarily compatible with the current configuration concerned, they can nevertheless be used as dual variables in the solution process.

4.3. A device for finding conduction routes. Searching for a conduction route for incremental current from σ_1^0 (input) to σ_m^0 (output) after a voltage-increasing step, we shall seldom fail to reach σ_m^0 if we start from σ_1^0 and trace arbitrarily along branches in state B, C or D, respectively, in the direction opposite to the orientation of the branch, in either direction, or in the same direction as the orientation of the branch, by virtue of Theorem 6 (§ 3.4). However, if there appears a

conduction loop, we may turn around the loop more than once. In such a case we must employ the rule that, if we arrive again at one of the nodes already reached, we choose another branch than that chosen before at the first node where it is possible. To avoid such a circuitous rule, the following device will be useful.

Let us modify the Θ -matrix as

$$\left. \begin{aligned} \theta_b^a &\rightarrow \theta_b^a && \text{if } \theta_b^a > 0 \text{ or } a = b, \\ \theta_b^a &\rightarrow \theta_b^a + \delta && \text{if } \theta_b^a \leq 0 \text{ and } a \neq b, \end{aligned} \right\} \quad (4.3.1)$$

where δ is a sufficiently small constant. Then, performing the same process as defined in §3.3 for a voltage-increasing step, we obtain a voltage configuration for this modified Θ . The voltage configuration becomes compatible if $\delta \rightarrow 0$, and the conduction routes defined in regard to it are free from loops. It is necessary to put $\delta \rightarrow 0$ in determining u .

4.4. A glance from the standpoint of the general network theory. Here we should like to refer to the fact that the above treatment is a special case of a more general network theory which we tentatively call the "theory of general information networks" [14], [15]. This general theory is established on the basis of topological and algebraic considerations of such a network problem as might be supposed to be the most general including all the existing types of network problems. Although the detailed explanation of the general theory lies beyond the scope of this paper, a few remarks will adequately be added from the algebraic and topological viewpoints (see [13], [14], [15], [16], etc.).

Let us give a few illustrations.

In the matrix Θ defined in §3.3 both the topological structure and the algebraic character of the network are reflected, i.e. $\theta_b^a < \infty$ means the existence of a branch connecting nodes σ_a^0 and σ_b^0 as well as the cost characteristic of that branch. This is apparently analogous to the well-known fact in electric network theory that an (a, b) -element of the node admittance matrix of an electric network indicates the existence or non-existence of branches between nodes σ_a^0 and σ_b^0 and, if any exists, (the sum of) their admittances [10], [21], and also to the character of a Boolean matrix in switching circuit theory [22], [23], [24].

The calculations concerning Θ -matrices can be viewed from the standpoint of the general theory as follows.

Let us define two operations \perp and \top over the set consisting of

real numbers and ∞ by

$$\left. \begin{aligned} x \perp y &= x + y, \\ x \top y &= \min(x, y), \end{aligned} \right\} \quad (4.4.1)$$

where

$$\left. \begin{aligned} x \perp \infty &= \infty \perp x = \infty, \\ x \top \infty &= \infty \top x = x, \end{aligned} \right\}$$

as will naturally be suggested. Then we have

$$\left. \begin{aligned} x \perp y &= y \perp x, & x \top y &= y \top x && \text{(commutativity);} \\ x \perp (y \perp z) &= (x \perp y) \perp z, & x \top (y \top z) &= (x \top y) \top z && \text{(associativity);} \\ x \perp (y \top z) &= (x \perp y) \top (x \perp z) &&&& \text{(distributivity).} \end{aligned} \right\} \quad (4.4.2)$$

The matrix multiplication is expressed in terms of \perp and \top as

$$\Theta * \Phi = (\theta_c^a) * (\phi_c^b) = \top_c (\theta_c^a \perp \phi_c^b), \quad (4.4.3)$$

which exactly coincides in form with the ordinary matrix multiplication, and we have many formulae analogous to those in the ordinary matrix algebra [15].

A manner of calculation, and a law of convergence, similar to those for Θ -matrices are observed also for Boolean matrices in switching circuit theory, where \perp and \top correspond to meet and join over a Boolean lattice. [24]

It is hoped that the above illustrations will serve to reveal the common general principle which lurks behind various kinds of network problems, suggesting the possibility of establishing a general network theory.

4.5. Tableaux for computation. In case the structure of a given transportation network is such that there are at most two branches connected between a pair of nodes, and that if two branches are connected between a pair of nodes they have opposite orientations, it is convenient to perform the computation in the form of tableaux as follows.

Given a compatible pair of current and voltage configurations, we have (θ_e, θ'_e) and $(c^e - s^e, s^e)$ for each branch, from which we can obtain at once the matrix Θ , where $c^e - s^e$ and s^e are the capacities, in the direction same as and opposite to the orientation of the branch, for incremental current. In order to express the states of branches on the matrix, it is advisable to write the (a, b) -element of Θ as

$$\theta_{\kappa}^{(j)}/\theta_{\lambda}^{(j)}, \tag{4.5.1}$$

where

$$\theta_b^a = \theta_{\kappa}^{(j)} = \min(\theta_{\kappa}^{(j)}, \theta_{\lambda}^{(j)}), \quad \text{i.e. } \theta_{\kappa}^{(j)} \leq \theta_{\lambda}^{(j)}, \tag{4.5.2}^{6)}$$

σ_{κ}^1 and σ_{λ}^1 being two branches connecting the pair of nodes σ_a^0 and σ_b^0 . (If $\theta_{\lambda}^{(j)} = \infty$, we write simply as $\theta_{\kappa}^{(j)}$ instead of $\theta_{\kappa}^{(j)}/\infty$.) The computation to obtain the voltage configurations may be performed with respect to the elements over /.

Furthermore we introduce another matrix C by defining

$$C = (c_b^a) : c_b^a = (c^{\epsilon} - s^{\epsilon})/s^{\lambda} \quad \text{or} \quad s^{\epsilon}/(c^{\lambda} - s^{\lambda}) \tag{4.5.3}$$

according as

$$\theta_b^a = \theta_{\kappa}/\theta'_{\lambda} \quad \text{or} \quad \theta'_{\kappa}/\theta_{\lambda}. \tag{4.5.4}$$

(If the value to be put under / is 0, we omit /0.) The elements of C are encircled whose correspondents in Θ satisfy the relation

$$\theta_b^a = u_b - u_a \tag{4.5.5}$$

A current-increasing step can be performed by searching for a route in reference to the non-vanishing elements of C over /, which are encircled, determining $\min c_b^a$ along the route and modifying C appropriately. After a current-increasing step, the modification of Θ is made according to the resulting form of the matrix C . For details, see the example in §5.1.

		a			
		1	2	m
$\Theta =$	1	0	$\theta_{1/x}^2$	$\theta_{1/x}^m$
	2	$\theta_{2/x}^1$	0	$\theta_{2/x}^m$
	⋮	⋮	⋮	0	⋮
	⋮	⋮	⋮	⋮	0
	m	$\theta_{m/x}^1$	$\theta_{m/x}^2$	0

(4.5.6)

6) The equality holds only when $\theta_{\kappa}^{(j)} = \theta_{\lambda}^{(j)} = 0$. Cf. also (3.3.5).

	<i>a</i>	1	2	m	
<i>b</i>						
1		0	
2		0	
.....		0	
m		0	

$C =$

(4.57)

4.6. Hitchcock problem and assignment problem. As was mentioned in §2.4.1, a transportation problem of the Hitchcock type (hence an assignment problem as a special case) can be regarded as the problem of determining a current configuration corresponding to the maxi-

	<i>a</i>	<i>i</i>	<i>j</i>		
<i>b</i>					
0	
<i>i</i>		d_{ij}	d_{in}
0		d_{m1}	d_{mn}
<i>j</i>	
0	
input		producers	consumers	output	

may be ignored by virtue of the second half of §4.2

$$\begin{cases} -d_{ij} & \text{if } x_{ij} > 0 \\ \infty & \text{if } x_{ij} = 0 \end{cases}$$

do not influence u_2 's since $u_m = 0$ and these entries are 0 or ∞

(4.6.1)

imum s in our general problem. However, the network structure for a Hitchcock problem is so simple (as shown is Fig. 2.4.1) that we may use tableaux of simpler form than those defined in § 4.5.

The Θ and C for an (uncapacitated) Hitchcock problem would be, according to § 4.5, as shown in (4.6.1) and (4.6.2) (cf. (1.1) and (1.2) for

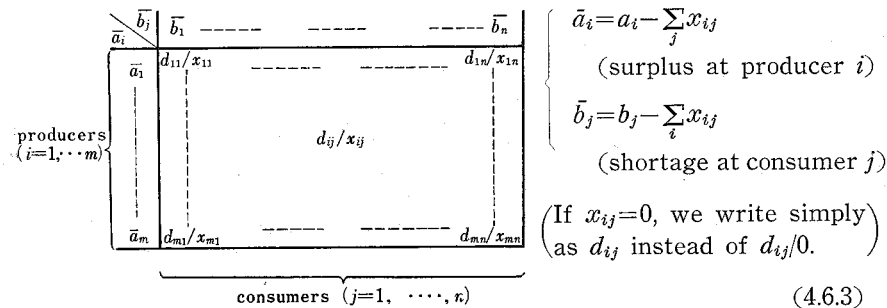
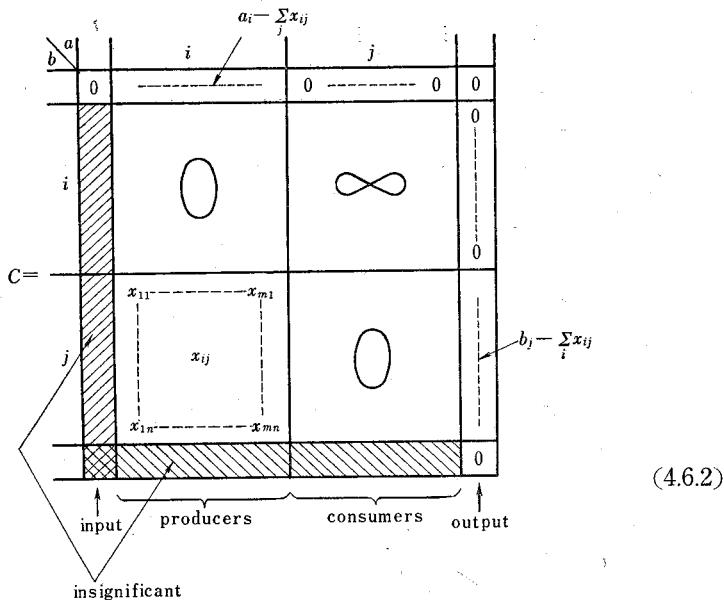

notations).

Such a form of tableau as shown in (4.6.1) and (4.6.2) is very redundant, so that we shall make use of the form (4.6.3)

We shall also resort to the simplified rule **t** to determine dual variables as follows (cf. (4.2.3)).

$$\left. \begin{aligned}
 \beta_j &= \begin{cases} 0 & \text{if } \bar{b}_j > 0, \\ \infty & \text{if } \bar{b}_j = 0; \end{cases} \\
 \alpha_i &= \min_j (d_{ij} + \beta_j); \\
 \beta_j &= \text{the smaller of } \beta_j \text{ and } \min_{i(x_{ij} > 0)} (\alpha_i - d_{ij}); \\
 \alpha_i &= \alpha_i, \quad \beta_j = \beta_j, \quad u = \min_{i(\alpha_i > 0)} \alpha_i;
 \end{aligned} \right\} \quad (4.6.4)$$

where we denote the dual variables by α_i, β_j instead of v_i, v_j, u_i, u_j , respectively.

The d_{ij} 's for which $d_{ij} = \alpha_i - \beta_j$, as well as the \bar{b}_j 's not equal to 0 and \bar{a}_i 's for which $\alpha_i = u$ and $\bar{a}_i > 0$, are encircled. Evidently the d_{ij} 's for which $x_{ij} > 0$ are always encircled. In a current-increasing step, we search for a route starting in the horizontal direction from an encircled \bar{a}_i and reaching an encircled \bar{b}_j , where it is permitted to turn from the horizontal direction to the vertical only at an encircled d_{ij} (or d_{ij}/x_{ij}) and from the vertical to the horizontal only at an d_{ij}/x_{ij} ($x_{ij} > 0$).

It seems needless to say that the above method is valid for an assignment problem as well and that a number of simplifications in computation are automatically done by virtue of the special properties possessed by the problem itself. These situations will be illustrated by a few examples in §5.

4.7. On the "out-of-kilter method" of Fulkerson. D. R. Fulkerson of the RAND Corporation recently proposed a method, to which he gives the name "out-of-kilter method" [25]. The method is very general in that it may be applied to a large variety of transportation-type problems and that we can make use of infeasible and incompatible configurations as well as feasible and compatible ones. As Dr. Fulkerson emphasized in his letter to the present author, the greatest merit of the out-of-kilter method is its flexibility. Let us review it in the following from our own standpoint, where it will be seen that our method

explained in the preceding sections is quite fundamental so that it can flexibly be extended also to the basis of the out-of-kilter method.⁷⁾

Let us consider the problem of determining a set of s^x 's which

$$\text{minimizes } f = \sum_{\kappa=1}^n e_{\kappa} s^{\kappa} \quad (4.7.1)$$

under the conditions

$$b^x \leq s^x \leq c^x \quad (4.7.2)$$

and

$$\sum_{\kappa=1}^n [\sigma_{\kappa}^1 : \sigma_{\alpha}^0] s^{\kappa} = 0 \quad \text{for all } a, \quad (4.7.3)$$

where b^x and c^x as well as e_{κ} may be positive, negative or zero, and suppose given a current configuration (i.e. a set of s^x 's) and a voltage configuration (i.e. a set of dual variables u_{α} 's at the respective nodes) which are not necessarily feasible nor compatible. Similar consideration to §3.1 makes us search for a pair of current and voltage configurations which satisfy

the feasibility conditions:

$$\left. \begin{aligned} b^x &\leq s^x \leq c^x, \\ \sum_{\kappa=1}^n [\sigma_{\kappa}^1 : \sigma_{\alpha}^0] s^{\kappa} &= 0 \quad \text{for all } a; \\ E_{\kappa} &\geq 0, \quad E'_{\kappa} \geq 0, \quad E_{\kappa} \cdot E'_{\kappa} = 0, \\ \sum_{\alpha=1}^m [\sigma_{\kappa}^1 : \sigma_{\alpha}^0] u_{\alpha} - E_{\kappa} + E'_{\kappa} &= e_{\kappa}, \end{aligned} \right\} \quad (4.7.4)$$

and

the optimality conditions:

$$\left. \begin{aligned} E'_{\kappa} &= 0 \quad \text{if } s^x > b^x, \\ E_{\kappa} &= 0 \quad \text{if } s^x < c^x. \end{aligned} \right\} \quad (4.7.5)$$

(The duality relation (3.1.1) becomes, in this case,

$$\begin{aligned} f &\equiv \sum_{\kappa=1}^n e_{\kappa} s^{\kappa} = \sum_{\kappa=1}^n (e_{\kappa} + E_{\kappa} - \sum_{\alpha=1}^m [\sigma_{\kappa}^1 : \sigma_{\alpha}^0] u_{\alpha}) s^{\kappa} - \sum_{\kappa=1}^n E_{\kappa} s^{\kappa} + \sum_{\kappa=1}^n \sum_{\alpha=1}^m [\sigma_{\kappa}^1 : \sigma_{\alpha}^0] u_{\alpha} s^{\kappa} \\ &= \sum_{\kappa=1}^n E'_{\kappa} s^{\kappa} - \sum_{\kappa=1}^n E_{\kappa} s^{\kappa} \geq \sum_{\kappa=1}^n b^x E'_{\kappa} - \sum_{\kappa=1}^n c^x E_{\kappa} \equiv g, \end{aligned}$$

7) Fulkerson's original algorithm expounded in [25] is seemingly different from ours, but one can easily understand the significance of Fulkerson's algorithm in [25] if one read through the following explanation of ours. It will not be difficult to see that the problem considered in the following is very general.

where the inequality is reduced to an equality if and only if the optimality conditions (4.7.5) are satisfied.)

In general the given pair of configurations will not satisfy all conditions, although we still assume (4.7.3) or the second equation of (4.7.4) holds for all a . In such a case we introduce a network so modified that the given configurations may be feasible and compatible with respect to it, i.e. if s^x 's, u_a 's are the given variables, we define

$$\left. \begin{aligned} \bar{l}^x &= b^x, & \bar{c}^x &= s^x & \text{if} & & s^x > c^x, \\ \bar{l}^x &= b^x, & \bar{c}^x &= c^x & \text{if} & & b^x \leq s^x \leq c^x, \\ \bar{l}^x &= s^x, & \bar{c}^x &= c^x & \text{if} & & s^x < b^x, \end{aligned} \right\} \quad (4.7.6)$$

and

$$\left. \begin{aligned} \bar{e}_x &= e_x & \text{if either} \\ & \sum_{a=1}^m [\sigma_a^1 : \sigma_a^0] u_a = e_x, \\ & \sum_{a=1}^m [\sigma_a^1 : \sigma_a^0] u_a > e_x & \text{and } s^x = \bar{c}^x, \\ & \text{or} \\ & \sum_{a=1}^m [\sigma_a^1 : \sigma_a^0] u_a < e_x & \text{and } s^x = \bar{l}^x; \\ \bar{e}_x &= \sum_{a=1}^m [\sigma_a^1 : \sigma_a^0] u_a & \text{otherwise.} \end{aligned} \right\} \quad (4.7.7)$$

Then, with regard to \bar{l}^x , \bar{c}^x , \bar{e}_x thus defined, the given currents s^x 's are feasible and it is possible to determine E_x 's and E'_x 's satisfying (4.7.5) and the last two equations of (4.7.4), i.e. the given configurations are feasible and compatible for the modified network. Let us further say, according to Fulkerson, that a branch is "in kilter" when

$$\bar{c}^x = c^x, \quad \bar{l}^x = b^x \text{ and } \bar{e}_x = e_x,$$

and is "out of kilter" otherwise.⁸⁾ (See Fig. 4.7.1.)

It seems convenient to divide the out-of-kilter region into two as shown in Fig. 4.7.1.

8) Fulkerson further introduces the concept of "kilter numbers", but it does not seem to be so essential as the concepts of "in-kilter" and "out-of-kilter".

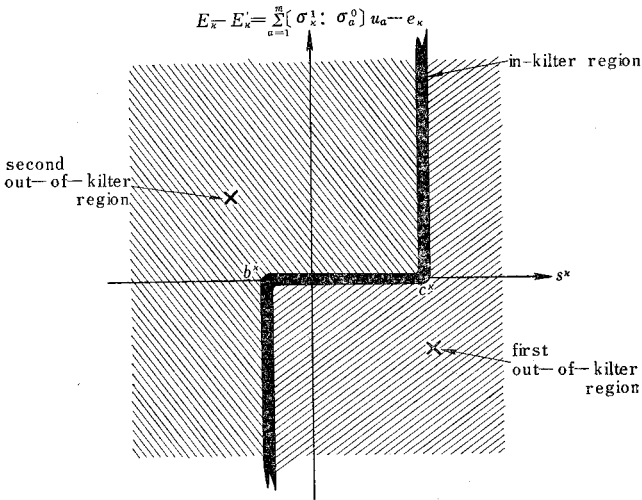

Fig. 4.7.1

If all the branches of the network are in kilter for the given current and voltage configurations, the given current configuration is a solution. Let us suppose some of the branches are out of kilter, and take up any one of the branches which are out of kilter. Let us assume it to be σ_i^1 . If it lies in the first (second) out-of-kilter region, we remove it from the network and consider the general transportation network problem for the resulting network regarding the nodes for which $[\sigma_i^1 : \sigma_a^0] = 1(-1)$ and $= -1(1)$ as the input and the output node, respectively. The only difference between the circumstances in § 2~§ 3 and those we now stand under is that, in the present case, \bar{t}^x 's are not necessarily 0 and \bar{e}_x 's not non-negative. Note, however, that the conditions $b^x=0$ and $e_x \geq 0$ were used only for the purpose of securing the existence of a compatible pair of feasible configurations ($s^x=0, u_\alpha=0$) throughout § 2~§ 3. The method explained there will easily be modified to the present case. The restriction for the voltage at the output node to be 0 is not essential either. It may be fixed to some constant (in the present case, to the given voltage) instead of 0. Let the input and the output node be denoted by σ_a^0 and σ_b^0 in case the removed branch σ_i^1 is in the first out-of-kilter region, or by σ_b^0 and σ_a^0 in case it is in the second out-of-kilter

region, i.e.

$$[\sigma_i^1 : \sigma_a^0] = 1 \quad \text{and} \quad [\sigma_i^1 : \sigma_b^0] = -1. \quad (4.7.8)$$

Then we get the relation between $u_a - u_b$ (or $u_b - u_a$) and the amount of the incremental input-output current (which latter is to be superposed on the current s^i and hence we shall denote by Δs^i .) It has already been seen that this relation is expressed as a monotonously non-decreasing step function either with $\Delta s^i \rightarrow \pm\infty$ for a certain finite $u_a - u_b$ (or $u_b - u_a$) or with $u_a - u_b$ (or $u_b - u_a$) $\rightarrow \infty$ for a certain finite Δs^i . Expressing this relation on the $s \sim (E_i - E'_i)$ plane (such as Fig. 4.7.1) we shall encounter the following cases:

(i) The branch σ_i^1 was in the first out-of-kilter region:—We have a step-function-like curve, which, starting from a point on the right side of the in-kilter region, is directed left- and upwards (Fig. 4.7.2 (a)). In this case, the curve either goes infinitely upwards on the right side of the in-kilter region or intersects the in-kilter region.

(ii) The branch σ_i^1 was in the second out-of-kilter region:—We have a step-function-like curve which, starting from a point on the left side of the in-kilter region, is directed right- and downwards (Fig. 4.7.2 (b)). In this case, the curve either goes infinitely downwards on the left side of the in-kilter region or intersects the in-kilter region.

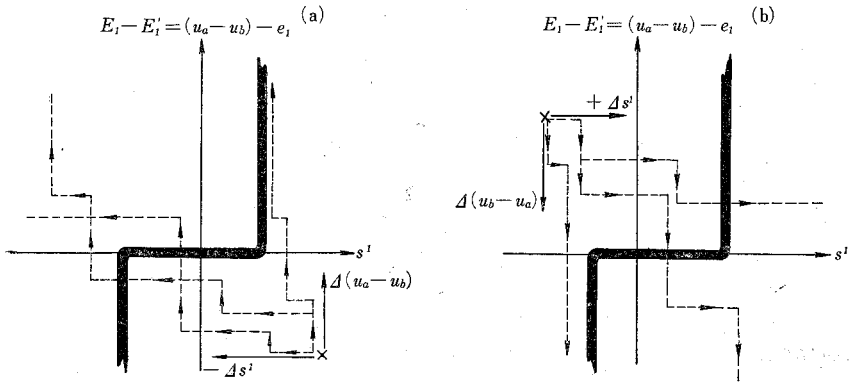

Fig. 4.7.2

In either case, if the curve does not intersect the in-kilter region, we can conclude that the original problem has no feasible solution. For,

it indicates that there exists no feasible current configuration even under "looser conditions" ($\tilde{b}^x \leq b^x$, $\tilde{c}^x \geq c^x$) regardless of voltages. (If one, or more, of c^x 's (b^x 's) is ∞ ($-\infty$), we have to replace it by a finite but sufficiently large value M ($-M$), chosen at random for each of such branches, and to follow the same procedure. If M is sufficiently large, this replacement will not affect the existence of feasible current configuration.)

If the curve does intersect the in-kilter region, we may regard the pair of current and voltage configurations which corresponds to that intersection point as the "improved" configurations which are to be considered as given in the next step. Through this process, the removed branch has been brought in kilter, so that we put $\tilde{b}^i = b^i$, $\tilde{c}^i = c^i$, $\tilde{e}_i = e_i$ for the removed branch. It is obvious that the branches which were in kilter before this step still remain in kilter. Thus the number of out-of-kilter branches has been diminished at least by one. (It may happen that some branches, which have not been removed, become also in kilter. In such a case, we may, or may not, put $\tilde{b}^x = b^x$, $\tilde{c}^x = c^x$, $\tilde{e}_x = e_x$ for those branches. If a certain branch has been brought in kilter during this process, we may stop the process, put $\tilde{b}^x = b^x$, $\tilde{c}^x = c^x$, $\tilde{e}_x = e_x$ for that branch, and then continue.)

Repeating this process we shall be able to bring all the branches in kilter so far as the original problem admits a feasible current configuration. (If, for the feasible current configuration and the voltage configuration compatible with it obtained in this way, a branch whose c^x (b^x) is substituted by M ($-M$) is in state A (E), the solution does not exist in the sense that f can become arbitrarily small, i.e. that it can tend to $-\infty$.)

5. EXAMPLES

We shall show, in this section, three examples of general transportation-network problems to illustrate the theory so far explained. The first of three examples will serve also as a model with which to understand the general theory (§5.1). The second is an example of application to a transportation problem of greatest practical use (§5.2), and the last shows how much our method simplifies the solution process of assignment problems clarifying the merit of our method and its difference

from the methods in current use (§ 5.3). (Cf. also the example of the shortest route problem in § 4.1)

5.1. Example of general transportation-network problem. In order to illustrate, step by step, the general theory expounded in the preceding sections, let us solve the general problem of transportation network such as follows. (Cf. § 4.5 for the forms of tableaux.)

Let the network structure of the problem be as shown in Fig. 5.1.1.

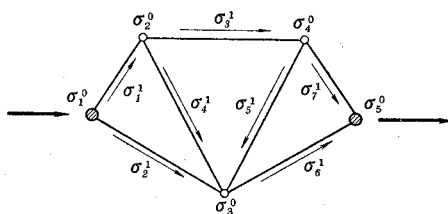
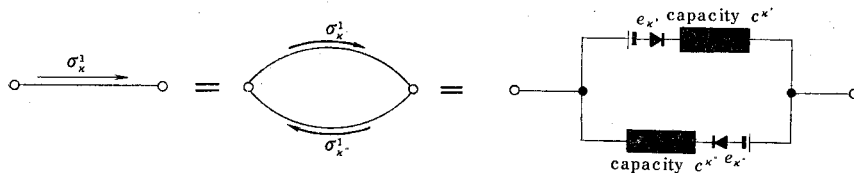

Fig. 5.1.1

Each route or branch (i.e. each of $\sigma_2^1, \sigma_3^1, \dots, \sigma_7^1$) has the finer structure as shown in Fig. 5.1.2; i.e. it consists of two branches connected in parallel which are provided with both capacity and cost characteristics shown in the table of Fig. 5.1.2.



x	1	2	3	4	5	6	7
e_k^1	1	2	1	1	2	4	2
c_k^1	1	2	1	1	1	1	2
e_k^1	1	2	1	2	1	2	4
c_k^1	1	1	1	1	1	1	1

Fig. 5.1.2

Let us observe the two-terminal characteristic of the network, i.e. the relation between s and u , regarding σ_1^0 and σ_5^0 as the input and the

output node, respectively.

Before going into the solution process, let us note that the structure of the network (Fig. 5.1.1) as well as the characteristics of branches (Fig. 5.1.2) can be fixed by writing the following two matrices.

(i) Θ -matrix in regard to the null-current configuration:—

$b \backslash a$	1	2	3	4	5
1	0	1	2	∞	∞
2	1	0	1	1	∞
3	2	2	0	1	4
4	∞	1	2	0	2
5	∞	∞	2	4	0

(5.1.1)

$\theta_b^a = \infty$ indicates that there is no branch connecting nodes σ_b^0 to σ_a^0 directly, while a finite θ_b^a denotes the cost per unit flow in the branch connecting σ_b^0 to σ_a^0 .

(ii) C -matrix in regard to the null-current configuration:—

$b \backslash a$	1	2	3	4	5
1	0	1	2	0	0
2	1	0	1	1	0
3	1	1	0	1	1
4	0	1	1	0	2
5	0	0	1	1	0

(5.1.2)

$c_b^a (>0)$ denotes the capacity of the branch connecting σ_b^0 to σ_a^0 .

< V_1 > The first voltage-increasing step:—If all $u_a = 0$ ($a=1,2,3,4,5$), all the branches are evidently in state E, so that no conduction route can be found from σ_1^0 (input) to σ_5^0 (output). Therefore the first step to follow is a voltage-increasing step. Now all the branches being in state E, the Θ -matrix to be used in the present step is exactly the same as (5.1.1). Then we calculate ' u_a 's according to the second formula of (4.2.3).

$$\left. \begin{aligned}
 & \begin{matrix} 0 \\ \mathbf{v} = (v_a) = \end{matrix} \begin{matrix} \backslash a & 1 & 2 & 3 & 4 & 5 \\ \infty & \infty & \infty & \infty & \infty & 0 \end{matrix}, \\
 & \begin{matrix} 1 \\ \mathbf{v} = (v_a) = \end{matrix} \begin{matrix} [& 4 & 3 & 3 & 2 & 0 \end{matrix}, \\
 & \begin{matrix} 2 \\ \mathbf{v} = \mathbf{v}' = \mathbf{u} = (u_a); \end{matrix} \\
 & \begin{matrix} 1 \\ u = u_1 = 4. \end{matrix}
 \end{aligned} \right\} \quad (5.1.3)$$

<C₁> The first current-increasing step:—The branches brought into state B, C or D through <V₁>, i.e. those for which $E_{k'} = E'_{k'} = 0$ or $E_{k''} = E'_{k''} = 0$, can be determined by testing whether or not $'u_b - 'u_a = \theta_b^a$ for the corresponding elements of Θ . The elements of C corresponding to such elements of Θ are marked by a circle in (5.1.4). A conduction

	<i>a</i>	1	2	3	4	5
<i>b</i>		1	2	3	4	5
①	1	0	①	2	0	0
2	1	0	1	①	0	0
C = 3	1	1	0	①	1	1
4	0	1	1	0	②	0
5	0	0	1	1	0	0

(5.1.4)

route from σ_1^0 to σ_5^0 is searched for by starting from the 1st row of C, looking for an encircled element to find $c_1^2 = \textcircled{1}$ in the 2nd column, then changing over to the 2nd row to find $c_2^4 = \textcircled{1}$ in the 4th column, and finally arriving at the 5th column of the 4th row ($c_4^5 = \textcircled{2}$), thus obtaining the route

$$\sigma_1^0 \rightarrow (\sigma_1^1) \rightarrow \sigma_2^0 \rightarrow (\sigma_2^1) \rightarrow \sigma_4^0 \rightarrow (\sigma_4^1) \rightarrow \sigma_5^0.$$

The maximum possible amount of current to assign along this route is $\min(c_1^2, c_2^4, c_4^5) = \min(1, 1, 2) = 1$. If this amount of current is assigned along this route, the capacities for incremental currents are modified in such a way that c_1^2, c_2^4, c_4^5 (elements along the conduction route) may be diminished by 1 (amount of assigned current) and c_2^1, c_4^2, c_5^4 (transpositional elements of c_1^2, c_2^4, c_4^5) may become $\textcircled{1}/1, \textcircled{1}/1, \textcircled{1}/1$, respectively, where $\textcircled{1}$ denotes the capacity of the reverse direction corresponding to

the current now existing in a branch along the conduction route, \circ showing that the branch remains still in state B, C or D, and $/1$ is the capacity of the partner branch having the opposite direction. Thus we have

$$C = \begin{array}{c|ccccc} & \begin{array}{c} a \\ b \end{array} & 1 & 2 & 3 & 4 & 5 \\ \hline 1 & & 0 & 0 & 2 & 0 & 0 \\ 2 & & \textcircled{1}/1 & 0 & 1 & 0 & 0 \\ 3 & & 1 & 1 & 0 & \textcircled{1} & 1 \\ 4 & & 0 & \textcircled{1}/1 & 1 & 0 & \textcircled{1} \\ 5 & & 0 & 0 & 1 & \textcircled{1}/1 & 0 \end{array} \quad (5.15)$$

where the circles are removed from null elements.

Since, obviously, no further conduction route can be found in C of (5.1.5), the first current-increasing step is completed with $\Delta s = 1$ and $\Delta f = u \Delta s = 4$.

The values under $/$ will not be used in the subsequent calculation until the values over $/$ become 0. When the value over $/$ becomes 0, the symbol $0/$ is removed and the value under $/$ will revive.

$\langle V_2 \rangle$ The second voltage-increasing step:—Referring to C in (5.1.5), we can determine the new θ -matrix to be used in $\langle V_2 \rangle$, i.e. we modify the θ in (5.1.1) in such a way that $\theta_b^{a_1}$'s corresponding to those $c_b^{a_1}$'s which have been made null in $\langle C_1 \rangle$ are rewritten as ∞ and $\theta_b^{a_2}$'s corresponding to the elements of C having the form \times/\times ($\times \neq 0$), as $-(\text{old } \theta_a^b)/(\text{old } \theta_b^a)$. Thus we have

$$\theta = \begin{array}{c|ccccc} & \begin{array}{c} a \\ b \end{array} & 1 & 2 & 3 & 4 & 5 \\ \hline 1 & & 0 & \infty & 2 & \infty & \infty \\ 2 & & -1/1 & 0 & 1 & \infty & \infty \\ 3 & & 2 & 2 & 0 & 1 & 4 \\ 4 & & \infty & -1/1 & 2 & 0 & 2 \\ 5 & & \infty & \infty & 2 & -2/4 & 0 \end{array} \quad (5.16)$$

Only the values over / are used in the following calculations, those under / being for memory. When the value over / is made ∞ some time, then the value under / will revive.

The new voltages are calculated as follows.

$$\left. \begin{aligned} v^0 &= [\infty \ \infty \ \infty \ \infty \ 0], \\ v^1 &= [5 \ 4 \ 3 \ 2 \ 0], \\ v^2 &= v^1 = u; \\ u^2 &= u^1 = 5. \end{aligned} \right\} \quad (5.1.7)$$

<C₂> The second current-increasing step:— Encircling the elements of C in (5.1.5) corresponding to those θ_b^a 's for which $u_b - u_a = \theta_b^a$, we have

	a	1	2	3	4	5
b						
①	1	0	0	②	0	0
2		①/1	0	①	0	0
3		1	1	0	①	1
4		0	1/1	1	0	①
5		0	0	1	①/1	0

(5.1.8)

and, searching for a conduction route by tracing the elements which are encircled, obtain the one indicated by the dotted line. The maximum amount of incremental current assignable along this route is determined to be $\min(2,1,1)=1$. Then C is modified into

	a	1	2	3	4	5
b						
1		0	0	①	0	0
2		①/1	0	①	0	0
3		①/1	1	0	0	1
4		0	1/1	①/1	0	0
5		0	0	1	②/1	0

(5.1.9)

where there is no more conduction route, for the only node attainable from σ_1^0 is σ_3^0 (since there is only one encircled element c_1^3 in the 1st row) but the only node attainable from σ_3^0 is σ_1^0 . Hence $\langle C_2 \rangle$ is completed with $\Delta s = 1$ and $\Delta f = u \Delta s = 5$.

$\langle V_3 \rangle$ The third voltage-increasing step:—As before, the new θ is determined from C in (5.1.9) and θ in (5.1.6) as follows.

	$a \backslash b$	1	2	3	4	5	
1		0	∞	2	∞	∞	
2		-1/1	0	1	∞	∞	
$\theta =$ 3		-2/2	2	0	∞	4	(5.1.10)
4		∞	-1/1	-1/2	0	∞	
5		∞	∞	2	-2/4	0	

The new voltages are

	$a \backslash$	1	2	3	4	5	
$v^0 =$	[∞	∞	∞	∞	0]	
$v^1 =$	[6	5	4	∞	0]	
$v^2 =$	[6	5	4	3	0]	(5.1.11)
$v^3 =$	$v^2 =$	u					
$u =$	$u_1 =$	6.					

$\langle C_3 \rangle$ The third current-increasing step:—The new C with circles is

	$a \backslash b$	1	2	3	4	5	
$\textcircled{1}$ 1		0	0	$\textcircled{1}$	0	0	(5.1.12)
2		$\textcircled{1}$ /1	0	$\textcircled{1}$	0	0	
$C =$ 3		$\textcircled{1}$ /1	1	0	0	$\textcircled{1}$	
4		0	1/1	$\textcircled{1}$ /1	0	0	
5		0	0	1	2/1	0	

The conduction route indicated by the dotted line is at once found together with the maximum amount 1 of current to be assigned. C is then modified into

	a	1	2	3	4	5	
b		1	2	3	4	5	
1		0	0	0	0	0	
2		①/1	0	①	0	0	
$C =$	3	②/1	1	0	0	0	
4		0	1/1	①/1	0	0	
5		0	0	①/1	2/1	0	

(5.1.13)

where we readily see that there is no conduction route. Thus $\langle C_3 \rangle$ is completed with $\Delta s = 1$ and $\Delta f = u \Delta s = 6$.

$\langle V_4 \rangle$ The fourth voltage-increasing step:—We have

	a	1	2	3	4	5	
b		1	2	3	4	5	
1		0	∞	∞	∞	∞	
2		-1/1	0	1	∞	∞	
$\theta =$	3	-2/2	2	0	∞	∞	
4		∞	-1/1	-1/2	0	∞	
5		∞	∞	-4/2	-2/4	0	

(5.1.14)

and

$$\left. \begin{aligned}
 & \begin{array}{c} \backslash a \\ \begin{matrix} 0 \\ \mathbf{v} = \end{matrix} \end{array} \begin{bmatrix} \infty & \infty & \infty & \infty & 0 \end{bmatrix}, \\
 & \begin{array}{c} 1 \\ \mathbf{v} = \end{array} \begin{array}{c} 0 \\ \mathbf{v} = \end{array} \mathbf{u}; \\
 & \begin{array}{c} 4 \\ \mathbf{u} = \end{array} \begin{array}{c} 1 \\ \mathbf{u}_1 = \end{array} \infty.
 \end{aligned} \right\} \quad (5.1.15)$$

Hence the solution process has come to an end.

It should be noted that the above procedure can be much more simplified in practical calculation; e.g. we need not write θ and C many

a time but may rewrite only the elements to be changed, nor need we carry out the encircling process before searching for a conduction route but may test, for each element in the row of C where searching goes on, whether it ought to have been encircled or not.

The above results can be summarized in the diagram and figures of Figs. 5.1.3~5.1.4, where node voltages u_a 's are put in \square and branch currents s^k 's are written by the side of the corresponding branches. (Note that current flows in that branch (σ_k^1 or $\sigma_k^{1'}$) which has the same direction as the arrow representing the current.) The incremental current assigned in each current-increasing step is shown by a dotted line.

The above results are available for the solution of various kinds of transportation problems on the network of Fig. 5.1.1 (and Fig. 5.1.2). For example,

(i) To maximize the current from σ_1^0 to σ_6^0 :—The solution is

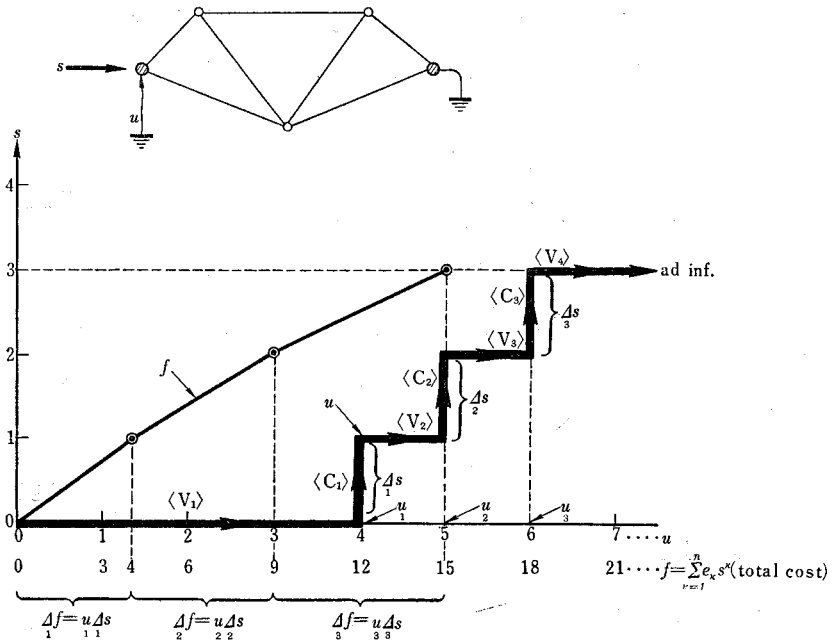

Fig. 5.1.3

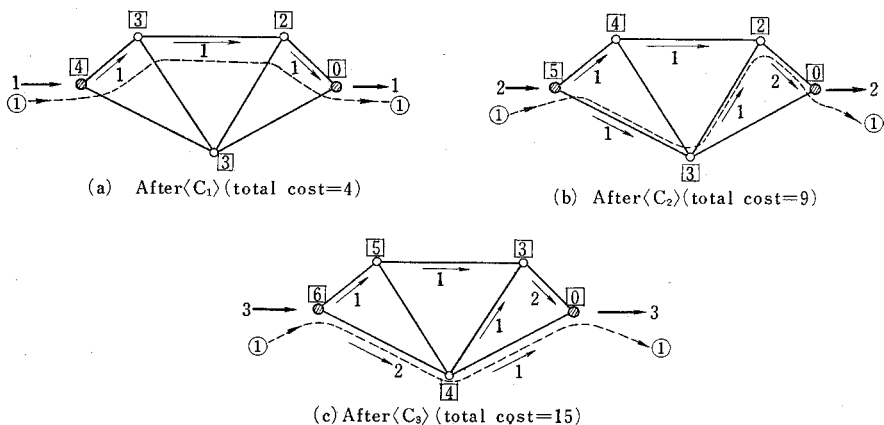

Fig. 5.1.4

given by Fig. 5.1.4(c).

- (ii) To obtain the current configuration which gives the maximum possible current from σ_1^0 to σ_5^0 and, moreover, minimize the total cost required under that condition:—Again Fig. 5.1.4(c) gives the solution.
- (iii) To make 2.5 units of current flow from σ_1^0 to σ_5^0 with as little expense as possible:—After $\langle C_2 \rangle$ we have 2 units of current and after $\langle C_3 \rangle$ 3 units. Therefore we may add to the current configuration obtained after $\langle C_2 \rangle$ 0.5 unit of current along the conduction route found in $\langle C_3 \rangle$; consequently, we have the configuration of Fig. 5.1.5, for which the total cost is equal to $9+6 \times 0.5=12$.

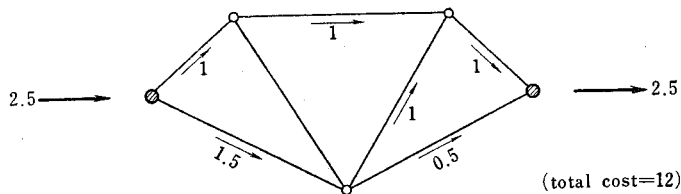

Fig. 5.1.5

- (iv) To make as much current as possible flow from σ_1^0 to σ_5^0 under the restriction $f(s) \leq 6$:—The total cost after $\langle C_1 \rangle$ is 4 and

that after $\langle C_2 \rangle$ is 9. Therefore, we may add to the current configuration obtained after $\langle C_1 \rangle$

$$\frac{6-4}{9-4} \times \Delta s = \frac{2}{5} \times 1 = 0.4$$

of incremental current along the conduction route in $\langle C_2 \rangle$, thus having the configuration of Fig. 5.1.6.

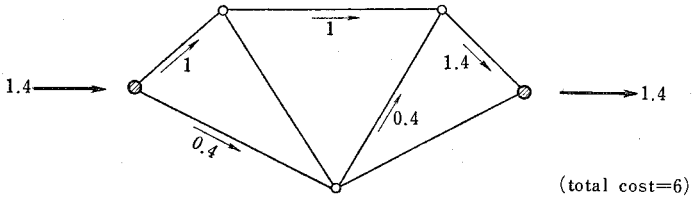

Fig. 5.1.6

5.2. Transportation problem of the Hitchcock type. The problems of the Hitchcock type which are usually solved by the stepping-stone method (revised simplex method) can easily be solved according to our general principle with the simplification proposed in §4.6. (As for notations see §1 and §4.6.)

Let us consider the Hitchcock problem with four producers and six consumers. From-producer-to-consumer transportation costs as well as the amounts of production and consumption are as shown in (5.2.1).

$a_i \backslash b_j$	3	3	6	2	1	2
3	5	3	7	3	8	5
4	5	6	12	5	7	11
2	2	8	3	4	8	2
8	9	6	10	5	10	9

d_{ij} 's

(5.2.1)

As is well known, the optimum solution for the original problem coincides with that for the modified problem having the matrix (d_{ij}) obtained from the given by subtracting from every element of a row the minimum of the elements of that row and then from every element of a column the minimum of the elements of that column. Thus,

subtracting 3, 5, 2 and 5 from the 1st, 2nd, 3rd and 4th row of (5.2.1) and then subtracting 1 and 2 from the 3rd and 5th column, we have

$a_i \backslash b_j$	3	3	6	2	1	2
3	2	0	3	0	3	2
4	0	1	6	0	0	6
2	0	6	0	2	4	0
8	4	1	4	0	3	4

(5.2.2)

The total cost for the modified problem is smaller than that for the original by

$$\begin{aligned} & \sum_i a_i \times (\text{subtrahend from the } i\text{-th row}) \\ & + \sum_j b_j \times (\text{subtrahend from the } j\text{-th column}). \\ & = (3 \times 3 + 4 \times 5 + 2 \times 2 + 8 \times 5) + (6 \times 1 + 1 \times 2) = 81. \end{aligned} \quad (5.2.3)$$

<V₁> Obviously, all $\alpha_i = \beta_j = 0$, and those d_{ij} 's which are equal to 0 as well as all \bar{a}_i 's and \bar{b}_j 's are encircled.

<C₁>

$\bar{a}_i \backslash \bar{b}_j$	③	③	⑥	②	①	②
③	2	①	3	①	3	2
③④	①	1	6	①	①	6
②	①	6	①	2	4	①
②⑧	4	1	4	①	3	4

(5.2.4)

$$u_1 = 0, \Delta s = 11$$

Thus we have $\Delta s = 11$ and $\Delta f = u_1 \Delta s = 0$, completing <C₁>.

The tableau is then modified as shown in (5.2.5).

<V₂ & C₂>

$\bar{a}_i \backslash \bar{b}_j$	0	0	⑥②	0	0	0
0	2	①/3	3	0	3	②
0	①/3	①	6	①	①/1	6
0	0	6	①	2	4	①/2
②⑥	4	①	4	①/2	3	4

$u=3, \Delta s=2$

The dual variables are calculated as follows (cf. (4.6.4)).

$$\begin{cases}
 (\beta_j^0) = [\infty \quad \infty \quad 0 \quad \infty \quad \infty \quad \infty] & \begin{matrix} \overbrace{(\alpha_i^1)} & \overbrace{(\alpha_i^3)} & \overbrace{(\alpha_i^5)} & \overbrace{(\alpha_i^7)} \\ \parallel & \parallel & \parallel & \parallel \\ \underline{3} & \underline{2} & \underline{2} & \underline{5} \end{matrix} \\
 (\beta_j^2) = [6 \quad 3 \quad 0 \quad 4 \quad 6 \quad 0] & \begin{matrix} \alpha_i \\ \parallel \\ \alpha_i \end{matrix} \\
 (\beta_j^4) = [4 \quad 2 \quad 0 \quad 4 \quad 4 \quad 0] & \begin{matrix} \alpha_i \\ \parallel \\ \alpha_i \end{matrix} \\
 (\beta_j^6) = [3 \quad 2 \quad 0 \quad 3 \quad 3 \quad 0] & \begin{matrix} \alpha_i \\ \parallel \\ \alpha_i \end{matrix} \\
 (\beta_j^8) = (\beta_j^6) = (\beta_j) & \begin{matrix} \alpha_i \\ \parallel \\ \alpha_i \end{matrix}
 \end{cases}$$

$$\begin{matrix}
 u=3 & \underline{4} & \underline{4} & \underline{3} \\
 & \phantom{\underline{4}} & \phantom{\underline{4}} & \phantom{\underline{3}}
 \end{matrix}
 \tag{5.2.6}$$

Encircling the d_{ij}/x_{ij} 's for which $\alpha_i = \beta_j + d_{ij}$ and the $\bar{a}_i (>0)$ for which $\alpha_i = u$, we obtain the conduction route from \bar{a}_4 to \bar{b}_3 along which 2 units of incremental current are assigned, as shown by dotted lines in (5.2.5). Thus we have $\Delta s=2$ and $\Delta f = u \Delta s = 6$, completing $\langle C_2 \rangle$.

$\langle V_3 \text{ \& } C_3 \rangle$

$\bar{a}_i \backslash \bar{b}_j$	0	0	④	0	0	0
0	2	①/1	3	0	3	②/2
0	①/3	①	6	①	①/1	6
0	0	6	①/2	2	4	2
④	4	①/2	④	①/2	3	4

$u=4, \Delta s=4$

$$\left\{ \begin{array}{l}
 (\beta_j^0) = [\infty \quad \infty \quad 0 \quad \infty \quad \infty \quad \infty] \\
 (\beta_j^2) = [6 \quad 3 \quad 0 \quad 4 \quad 6 \quad 1] \\
 (\beta_j^4) = [4 \quad 3 \quad 0 \quad 4 \quad 4 \quad 1] \\
 (\beta_j^6) = (\beta_j^4) = (\beta_j)
 \end{array} \right. \quad \overbrace{\begin{array}{l}
 (\alpha_i^1) \quad (\alpha_i^3) \quad (\alpha_i^5) \\
 \parallel \quad \parallel \quad \parallel \\
 3 \quad 3 \quad (\alpha_i) \\
 6 \quad 4 \quad (\alpha_i) \\
 0 \quad 0 \\
 \underline{4} \quad \underline{4}
 \end{array}} \quad (5.2.8)$$

Thus we have $\Delta s = 4$ and $\Delta f = u \Delta s = 16$, completing $\langle C_3 \rangle$. The tableau is then modified into

$\bar{a}_i \backslash \bar{b}_j$	0	0	0	0	0	0
0	2	0/1	3	0	0	2/2
0	0/3	1	6	0	0/1	6
0	0	6	0/2	2	4	2
0	4	1/2	4/4	0/2	3	4

(5.2.9)

In (5.2.9), however, all \bar{a}_i 's as well as all \bar{b}_j 's are 0, which indicates the termination of the whole solution process. The optimum values of x_{ij} 's can be obtained immediately from (5.2.9) by gathering the values under /; i.e. we have

$\backslash \begin{matrix} j \\ i \end{matrix}$	1	2	3	4	5	6
1	0	1	0	0	0	2
2	3	0	0	0	1	0
3	0	0	2	0	0	0
4	0	2	4	2	0	0

(5.2.10)

The total cost required for the optimum solution is calculated by (3.2.5)

with the modification of (5.2.3) taken into account:

$$f=81+\Delta f_1+\Delta f_2+\Delta f_8=81+0+6+16=103. \quad (5.2.11)$$

5.3. Application to assignment problems. As was already mentioned in the introductory part of this paper, an assignment problem can be regarded as a transportation problem of the Hitchcock type with an additional condition that x_{ij} 's should be either 0 or 1. However, if we apply the method proposed in this paper (see especially §4.6 and §5.2) to an assignment problem without paying attention to the additional condition, we shall see the condition automatically satisfied in the solution thus obtained. As an example let us solve the 10×10 assignment problem treated in [2]. The comparison with the solution by the Hungarian method (which is believed to be the best among all the currently available methods [2]) will reveal the advantages of our method.

Notable is the fact that our general method is extremely simplified when applied to an assignment problem since in the course of calculation

- (i) every \bar{a}_i as well as every \bar{b}_j always takes one of the values 0 and 1;
- (ii) an x_{ij} is either 0 or 1, and there lies at most one $x_{ij}=1$ in each column as well as in each row;
- (iii) if a conduction route is found from an encircled \bar{a}_i ($=1$) to an encircled \bar{b}_j ($=1$), the amount of incremental current to be assigned along the route is always 1, and the modification of the values of \bar{a}_i 's, \bar{b}_j 's and x_{ij} 's along the route is mere inter-

$b_j \backslash a_i$	1	1	1	1	1	1	1	1	1	1
1	4.1	4.1	7.9	8.3	2.6	8.7	7.1	9.9	2.2	9.4
1	4.6	6.1	4.5	0.9	4.8	6.4	8.8	6.2	0	0.2
1	9.7	3.6	5.3	0.9	7.6	2.8	3.5	7.9	4.0	7.0
1	2.0	6.5	2.3	5.7	7.4	1.6	2.4	9.7	5.0	1.9
1	2.1	1.4	5.0	5.2	1.7	4.7	2.8	6.7	6.3	0.5
1	1.7	7.8	3.0	0	1.5	1.0	8.0	6.8	3.0	9.1
1	9.1	5.3	0.3	6.4	6.6	3.9	9.8	1.6	2.4	8.1
1	4.9	1.7	7.7	5.7	7.9	4.0	9.5	0.8	4.8	2.0
1	2.9	8.8	1.8	5.9	6.6	6.2	8.8	0.7	0.3	2.6
1	8.4	7.4	0.6	2.6	6.0	7.7	3.7	9.9	0.2	7.9

(5.3.1)

change of 0 and 1;
 etc. However, since these simplifications are made *automatically* according to our method, no special attention need be paid thereto.

Let (5.3.1) be the problem to be solved. Modifying it as

$$d_{ij} \rightarrow d_{ij} - \min_{i_1} (d_{i,j}) - \min_{j_1} \{d_{i,j} - \min_{i_1} (d_{i,j})\}, \tag{5.3.2}$$

we have

b_j	1	1	1	1	1	1	1	1	1	1	
a_i	1	1.3	1.6	6.5	7.2	0	6.6	3.6	8.1	1.1	8.1
	1	2.9	4.7	4.2	0.9	3.3	5.4	6.4	5.5	0	0
	1	7.1	1.3	4.1	0	5.2	0.9	0.2	6.3	3.1	5.9
	1	0.3	5.1	2.0	5.7	5.9	0.6	0	9.0	5.0	1.7
	1	0.4	0	4.7	5.2	0.2	3.7	0.4	6.0	6.3	0.3
	1	0	6.4	2.7	0	0	0	5.6	6.1	3.0	8.9
	1	7.4	3.9	0	6.4	5.1	2.9	7.4	0.9	2.4	7.9
	1	3.1	0.2	7.3	5.6	6.3	2.9	7.0	0	4.7	1.7
	1	1.2	7.4	1.5	5.9	5.1	5.2	6.4	0	0.3	2.4
	1	6.5	5.8	0.1	2.4	4.3	6.5	1.1	9.0	0	7.5

The total cost is diminished by

$$(1.7+1.4+0.3+0+1.5+1.0+2.4+0.7+0+0.2) + (1.1+0+0.9+0+0+0+0+0.1+0+0.2) = 11.5 \tag{5.3.4}$$

by this modification.

<V₁ & C₁> Obviously

$$\alpha_1 = \alpha_2 = \dots = \alpha_{10} = \beta_1 = \dots = \beta_{10} = 0, \tag{5.3.5}$$

and all \bar{a}_i 's and all \bar{b}_j 's, as well as d_{ij} 's which are equal to 0, are encircled. (Hence circles will be omitted in (5.3.6)). The assignment in <C₁> is shown in (5.3.6)

<V₂ & C₂> The tableau is modified as shown in (5.3.7), and the dual variables are calculated as in (5.3.8). Without performing the encircling process in advance, we search for a conduction route from \bar{a}_9 , to \bar{b}_6 examining, at each place where necessary, whether a d_{ij} ought to have been encircled or not. (It is known that every $d_{ij}/1$ is encircled!) Thus we obtain the conduction route indicated by dotted lines in (5.3.7).

\bar{b}_j	(1)	(1)	(1)	(1)	(1)	1	(1)	(1)	(1)	(1)
\bar{a}_i	(1)	(1)	(1)	(1)	(1)	(1)	(1)	(1)	(1)	(1)
(1)	1.3	1.6	6.5	7.2	0	6.6	3.6	8.1	1.1	8.1
(1)	2.9	4.7	4.2	0.9	3.3	5.4	6.4	5.5	0	0
(1)	7.1	1.3	4.1	0	5.2	0.9	0.2	6.3	3.1	5.9
(1)	0.3	5.1	2.0	5.7	5.9	0.6	0	9.0	5.0	1.7
(1)	0.4	0	4.7	5.2	0.2	3.7	0.4	6.0	6.3	0.3
(1)	0	6.4	2.7	0	0	0	5.6	6.1	3.0	8.9
(1)	7.4	3.9	0	6.4	5.1	2.9	7.4	0.9	2.4	7.9
(1)	3.1	0.2	7.3	5.6	6.3	2.9	7.0	0	4.7	1.7
1	1.2	7.4	1.5	5.9	5.1	5.2	6.4	0	0.3	2.4
(1)	6.5	5.8	0.1	2.4	4.3	6.5	1.1	9.0	0	7.5

(5.36)

$$u=0, \Delta s=9, \Delta f=u\Delta s=0$$

\bar{b}_j	0	0	0	0	0	(1)	0	0	0	0
\bar{a}_i	0	0	0	0	0	0	0	0	0	0
0	1.3	1.6	6.5	7.2	0/1	6.6	3.6	8.1	1.1	8.1
0	2.9	4.7	4.2	0.9	3.3	5.4	6.4	5.5	0	0/1
0	7.1	1.3	4.1	0/1	5.2	0.9	0.2	6.3	3.1	5.9
0	0.3	5.1	2.0	5.7	5.9	0.6	0/1	9.0	5.0	1.7
0	0.4	0/1	4.7	5.2	0.2	3.7	0.4	6.0	6.3	0.3
0	0/1	6.4	2.7	0	0	0	5.6	6.1	3.0	8.9
0	7.4	3.9	0/1	6.4	5.1	2.9	7.4	0.9	2.4	7.9
0	3.1	0.2	7.3	5.6	6.3	2.9	7.0	0/1	4.7	1.7
(1)	1.2	7.4	1.5	5.9	5.1	5.2	6.4	0	0.3	2.4
0	6.5	5.8	0.1	2.4	4.3	6.5	1.1	9.0	0/1	7.5

(5.37)

$$u=0.6, \Delta s=1, \Delta f=u\Delta s=0.6$$

$$\left\{ \begin{array}{l}
 (\beta_j^0) = [\infty \ \infty \ \infty \ \infty \ \infty \ 0 \ \infty \ \infty \ \infty \ \infty] \\
 (\beta_j^2) = [0 \ 3.7 \ 2.9 \ 0.9 \ 6.6 \ 0 \ 0.6 \ 2.9 \ 6.5 \ 5.4] \\
 (\beta_j^4) = [0 \ 0.4 \ 2.9 \ 0.8 \ 1.3 \ 0 \ 0.3 \ 2.9 \ 1.7 \ 1.8] \\
 (\beta_j^6) = [0 \ 0.4 \ 2.9 \ 0.5 \ 1.3 \ 0 \ 0.3 \ 0.6 \ 1.4 \ 1.7] \\
 (\beta_j^8) = [0 \ 0.4 \ 1.5 \ 0.5 \ 1.3 \ 0 \ 0.3 \ 0.6 \ 1.4 \ 1.4] \\
 (\beta_j^{10}) = (\beta_j^8) = (\beta_j^6)
 \end{array} \right. \begin{array}{l}
 \overbrace{(\alpha_i^1)} \quad \overbrace{(\alpha_i^3)} \quad \overbrace{(\alpha_i^5)} \quad \overbrace{(\alpha_i^7)} \quad \overbrace{(\alpha_i^9)} \\
 \parallel \quad \parallel \quad \parallel \quad \parallel \quad \parallel \\
 \underline{6.6} \quad \underline{1.3} \quad \underline{1.3} \quad \underline{1.3} \quad (\alpha_i^7) \\
 5.4 \quad 1.8 \quad 1.7 \quad 1.4 \quad \parallel \\
 0.9 \quad 0.8 \quad 0.5 \quad 0.5 \quad (\alpha_i^9) \\
 0.6 \quad 0.3 \quad 0.3 \quad 0.3 \\
 3.7 \quad 0.4 \quad 0.4 \quad 0.4 \\
 0 \quad 0 \quad 0 \quad 0 \\
 2.9 \quad 2.9 \quad 2.9 \quad 1.5 \\
 2.9 \quad 2.9 \quad 0.6 \quad 0.6 \\
 5.2 \quad 1.2 \quad 1.2 \quad 0.6 \\
 \underline{6.5} \quad \underline{1.7} \quad \underline{1.4} \quad \underline{1.4}
 \end{array} \tag{5.3.8}$$

$$u = 0.6$$

Since $\sum_1 A_s + \sum_2 A_s = 10$, we have the following optimum assignment from (5.3.7).

0	0	0	0	1	0	0	0	0	0
0	0	0	0	0	0	0	0	0	1
0	0	0	1	0	0	0	0	0	0
0	0	0	0	0	0	1	0	0	0
1	0	0	0	0	0	0	0	0	0
0	0	0	0	0	1	0	0	0	0
0	0	1	0	0	0	0	0	0	0
0	1	0	0	0	0	0	0	0	0
0	0	0	0	0	0	0	1	0	0
0	0	0	0	0	0	0	0	1	0

(5.3.9)

The total cost corresponding to (5.3.9) is determined from (5.3.4), (5.3.6) and (5.3.7):

$$f = 11.5 + 0 + 0.6 = 12.1. \tag{5.3.10}$$

According to the Hungarian method, we modify the matrix of (5.3.1) into (5.3.3), then, searching for a smallest set of lines (rows and columns) which cover all the 0's and determining the value of the least elements not lying on those lines, subtract it from all the elements not lying on the lines and add it to the elements situated at the intersections of the lines, and again search for a smallest set of lines covering all the 0's in the matrix thus resulting, and so on, repeating until the minimum number of covering lines becomes equal to the order of the matrix (=

10 in the present example). In [2], three repetitions of the above process is needed to arrive at the optimum assignment beginning with (5.3.3). In contrast with this, our method requires essentially one step (5.3.7).

REFERENCES

- [1] F. L. Hitchcock, The Distribution of a Product from Several Sources to Numerous Localities. *Journal of Mathematics and Physics*, Vol. 20 (1941), pp. 224~230.
- [2] C. W. Churchman, R. A. Ackoff and E. L. Arnoff, *Introduction to Operations Research*. John Wiley & Sons, New York, 1957.
- [3] M. Sasieni, A. Yaspan and L. Friedman, *Operations Research' Methods and Problems*. John Wiley & Sons, New York, 1959.
- [4] H. S. Houthakker, On the Numerical Solution of the Transportation Problem. *Journal of the Operations Research Society of America*, Vol. 3, No. 2 (1955), pp. 210~214.
- [5] L. R. Ford, Jr., and D. R. Fulkerson, A Simple Algorithm for Finding Maximal Network Flows and an Application to the Hitchcock Problem. *Canadian Journal of Mathematics*, Vol. 9 (1957), pp. 210~218.
- [6] L. R. Ford, Jr., and D. R. Fulkerson, A Primal-Dual Algorithm for the Capacitated Hitchcock Problem. *Naval Research Logistic Quarterly*, Vol. 4, No. 1 (1957), pp. 47~54.
- [7] T. Fujisawa, A Computational Method for the Transportation Problem on a Network. *Journal of the Operations Research Society of Japan*, Vol. 1, No. 4 (1958), pp. 157~174.
- [8] L. R. Ford, Jr., and D. R. Fulkerson, Constructing Maximal Dynamic Flows from Static Flows. *Journal of the Operations Research Society of America*, Vol. 6 (1958), pp. 419~433.
- [9] D. R. Fulkerson, Increasing the Capacity of a Network: The Parametric Budget Problem. *Management Science*, Vol. 5, No. 4 (1959), pp. 472~483.
- [10] K. Kondo and M. Iri, On the Theory of Trees, Cotrees, Multi-Trees and Multi-Cotrees. *RAAG Memoirs*, Vol. 2, A-VII (1958), pp. 42~83.
- [11] Y. Mizoo, M. Iri and K. Kondo, On the Torsion and Linkage Characteristics and the Duality of Electric, Magnetic and Dielectric Networks. *RAAG Memoirs*, Vol. 2, A-VIII (1958), pp. 84~117.
- [12] T. Sunaga and M. Iri, Theory of Communication and Transportation Networks. *RAAG Memoirs*, Vol. 2, G-II (1958), pp. 444~468.
- [13] M. Iri, Algebraic and Topological Theory of the Problems of Transportation Networks with the Help of Electric Circuit Models. *RAAG Research*

Notes, Third Series, No. 13 (September 1959).

- [14] M. Iri, *On the Basic Theory of General Information Networks and its Applications*. Doctoral Thesis submitted to the Division of Research in Mathematical and Physical Sciences of the Graduate School of the University of Tokyo, March 1960.
- [15] M. Iri, *Fundamentals of the Algebraic and Topological Treatments of General Information Networks*. To be published as a *RAAG Research Note*.†
- [16] M. Iri, Sh. Amari and M. Takata, *Linear Programming with Weak Graphical Representation*. To be published as a *RAAG Research Note*.
- [17] J. B. Dennis, *Mathematical Programming and Electrical Networks*. MIT Technology Press, joint with John Wiley & Sons, New York, 1959.
- [18] G. B. Dantzig, *Discrete-Variable Extremum Problems*. *Journal of the Operations Research Society of America*, Vol. 5, No. 2 (1957), pp. 266~277.
- [19] A. Shimbel, *Structure in Communication Nets*. *Proceedings of the Symposium on Information Networks* (April 12, 13 and 14, 1954), Vol. 3, pp. 199~203, Polytechnic Institute of Brooklyn, New York, 1955.
- [20] G. B. Dantzig, *On the Shortest Route through a Network*. *Management Science*, Vol. 6, No. 2 (1960), pp. 187~190.
- See also the references cited in [18], [19] and [20].
- [21] S. Okada and R. Onodera, *A Unified Treatise on the Theory of Networks*. *RAAG Memoirs*, Vol. 1, A-II (1955), pp. 68~112.
- [22] А. Г. Луниц, Приложение Матричной Булевой Алгебры к Анализу и Синтезу Релейно-Контактных Схем. *Доклады Академии Наук СССР*, том 70 (1950), стр. 420~423.
- [23] F. E. Hohn and L. R. Schissler, *Boolean Matrix and the Design of Combinatorial Relay Switching Circuits*. *Bell System Technical Journal*, Vol. 34 (1955), pp. 177~202.
- [24] M. Iri, *Algebraic and Topological Foundations of the Analysis and Synthesis of Oriented Switching Circuits*. *RAAG Memoirs*, Vol. 2, G-III (1958), pp. 469~518.
- [25] D. R. Fulkerson, *An Out-of-Kilter Method for Minimal Cost Flow Problems*. Mimeographical Note, reproduced as P-1825 by the RAND Corporation, January 1960.

† Published as *RAAG Research Note, Third Series*, No. 30 (August 1960) :
— added in proof.